

SG 6100

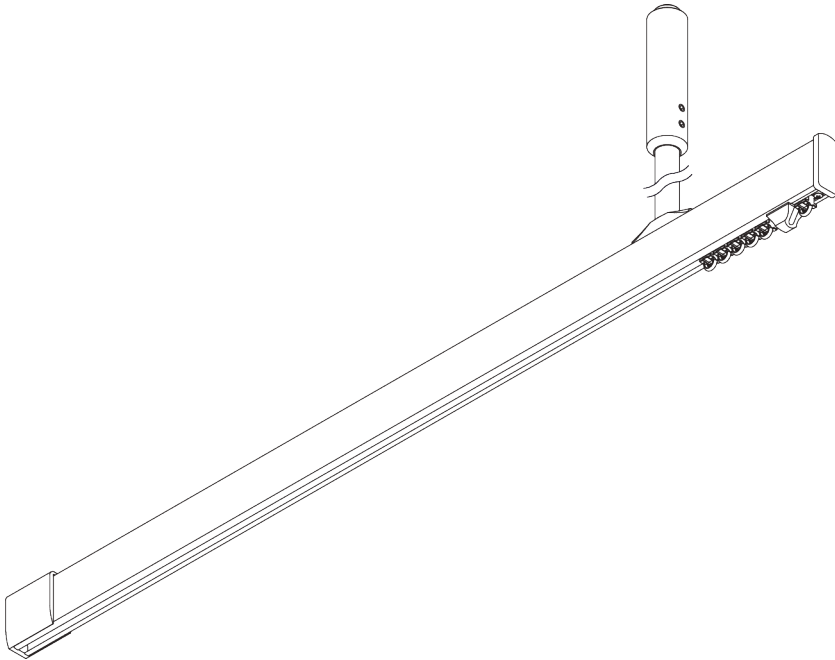

PRODUCT INFORMATION

- **Operation:** hand
- **Range:** S - L
- **Fitting:** suspended, ceiling, wall
- **Colours:** white RAL 9016, black RAL 9005 or anodised aluminum, special colours possible
- **Fabrics:** refer to Silent Gliss fabric collection

Features:

- Universal room divider
- 2-component (2C) glider technology
- Wave (2C)
- Suspended
- Versatile layouts
- Bendable
- White paint incorporates anti-microbial coating as standard

SYSTEM SPECIFICATIONS

A. PROFILE

Profile and bending information

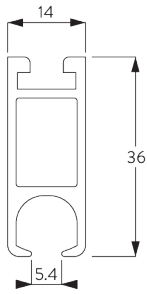

SG 6101

Profile

Radius:
20 cm, >25 cm

B. HOW TO MEASURE

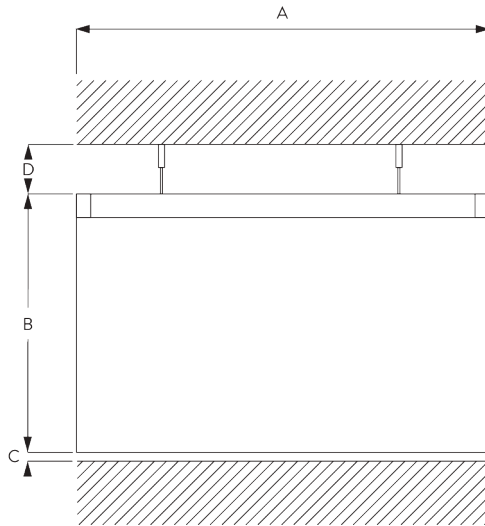

A: System width

B: System height

C: Distance between floor and fabric

D: Distance between ceiling and system

C. SPECIFICATION TEXT

Silent Gliss SG 6100 Cubicle Track System. Comprises aluminium profile SG 6101 in satin anodised / white / black powder coated finish supplied made to measure with nylon glider hook SG 6147 at 10/m. Installed with the following parts depending on the system configuration: Delrin wall support SG 6609 / Dust cover SG 6110 / Ceiling fix bracket SG 6137 / Wall bracket SG 6503 / T bracket SG 6514 / Twist fixing plate SG 6124 / Ceiling fix bracket SG 6138 / Ceiling support SG 6175 / Internal bridge SG 6199 / Connecting bridge SG 6512 / Cross connection SG 6525 / End cover SG 6611 / Hanger rod SG 6190 / V-hanger rod SG 6501.

FITTING

A. FITTING INFORMATION

For detailed fitting information, visit the Silent Gliss website.

Fixing points

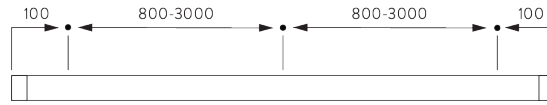

Dust cover

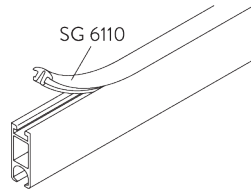

Site preparation for suspended ceiling applications

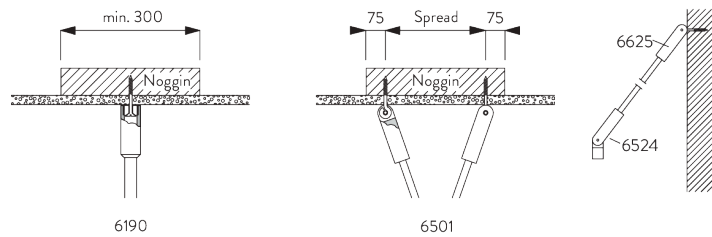

- Fixings should support the ends of the profile and any changes in direction.
- Maximum span between fixings is 3000 mm.
- When fitting to suspended ceilings site preparation is critical.
- At each hanger position a noggin in approved material is required above the suspended ceiling; underside to rest on top of ceiling (but independently supported) with a minimum length of 300 mm at right angles to the track in which the hanger occurs to give fixing tolerance.
- Ideally the hangers should be on the return track, if on the front track then adequate support should be provided.
- A detailed information sheet is available on request.

Diagonal fixing supports can be used to return the hanger to the bedhead wall, but only for use when it is impossible to ceiling fix.

B. CEILING FITTING

Hanger SG 6190

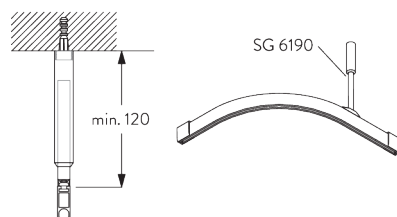

Can also be fixed in suspended ceilings by using sleeves SG 6187 & SG 6188.

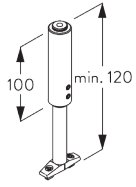

SG 6190

Hanger

Mini hanger SG 6175

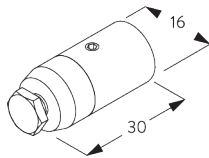
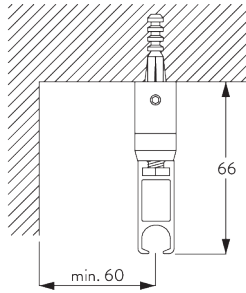

SG 6175

Mini hanger

Bracket SG 6124

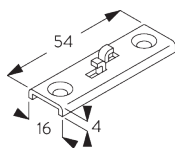
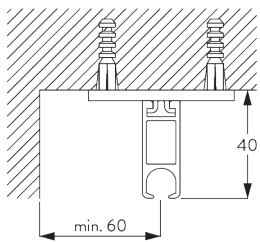

SG 6124

Bracket

V-hanger

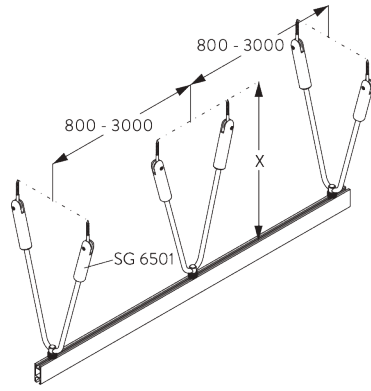

SG 6501:
V-hangers provide additional lateral stability.

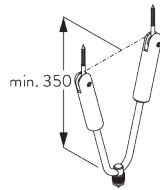

SG 6501
V-Hanger

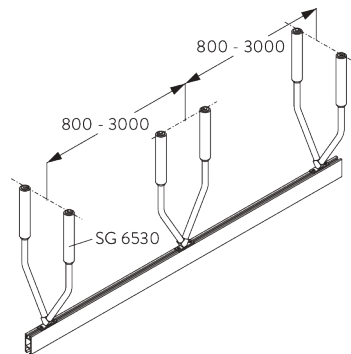

SG 6530:
V-hangers provide additional lateral stability.

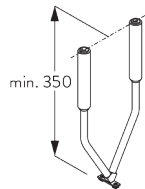

SG 6530
V-Hanger

C. WALL FITTING

Smart Fix

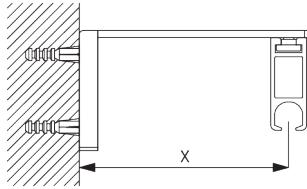

Smart Fix with slot SG 11206 - SG 11208:
Screw SG 10492 (M4x8) needed.

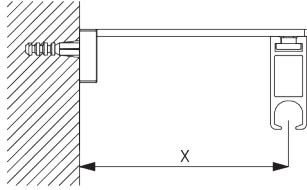

Square Smart Fix with slot SG 11216 - SG 11218:
Screw SG 10492 (M4x8) needed.

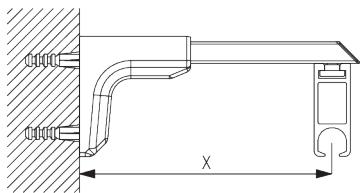

Universal Smart Fix SG 11154 - SG 11156:
Screw SG 11131 (M4x6) needed.

Smart Fix	X mm
SG 11206 / SG 11216	33-51
SG 11207 / SG 11217	53-71
SG 11208 / SG 11218	73-91
SG 11154	102-130
SG 11155	132-160
SG 11156	182-210

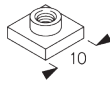

SG 6117
Slot nut



SG 10492
Pan head screw M4x8



SG 11131
Pan head screw with flange
M4x6

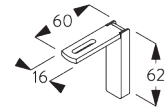

SG 11206
Smart Fix with slot 60 mm

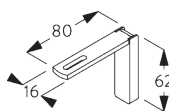

SG 11207
Smart Fix with slot 80 mm

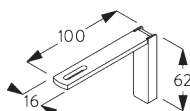

SG 11208
Smart Fix with slot 100 mm

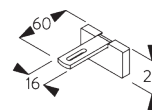

SG 11216
Square Smart Fix with slot 60 mm

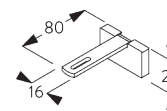

SG 11217
Square Smart Fix with slot 80 mm

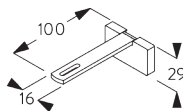

SG 11218
Square Smart Fix with slot
100 mm

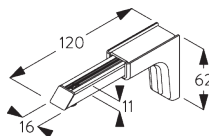

SG 11154
Universal Smart Fix 120 mm

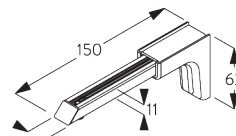

SG 11155
Universal Smart Fix 150 mm

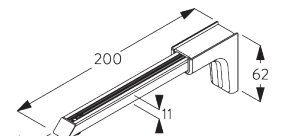

SG 11156
Universal Smart Fix 200 mm

Wall support SG 6610

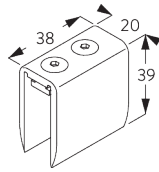
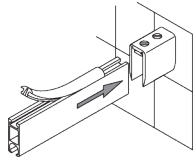

SG 6610

Wall support

Bracket SG 6503

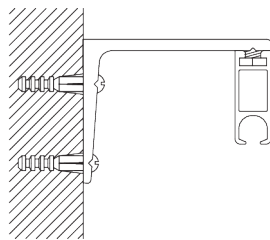

Bracket SG 6503 is available in various sizes, enquire at Silent Gliss.

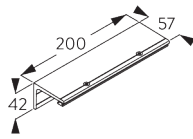

SG 6503

Bracket

D. PROFILE JUNCTIONS

Connection bridges SG 6123 & SG 6514

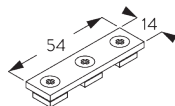
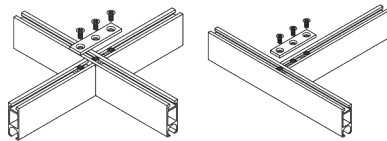

SG 6123

Connection plate

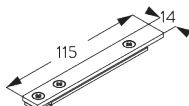

SG 6514

T-Junction

**Connecting bridge
SG 6512**

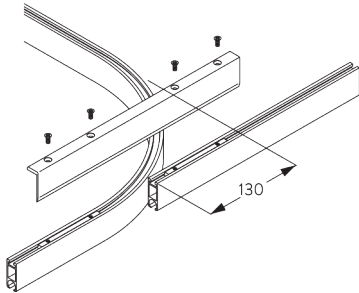
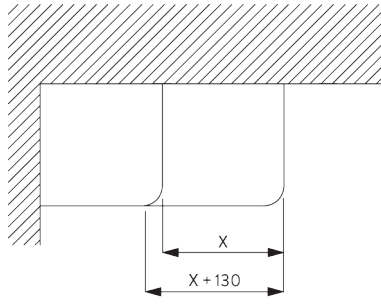

Note: be sure to attach a sketch!

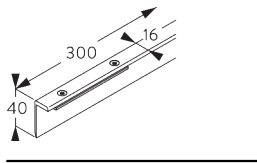

SG 6512

Connection bridge

SYSTEM OPTIONS

A. LAYOUT OPTIONS

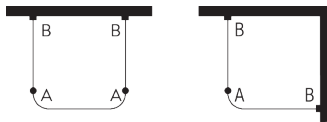

*A: Hanger rod
B: Wall support*

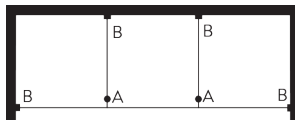

*A: Hanger rod
B: Wall support*

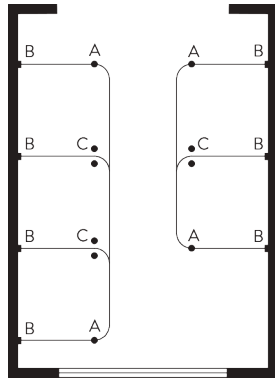

A: Hanger rod
 B: Wall support
 C: V-hanger

B. WAVE

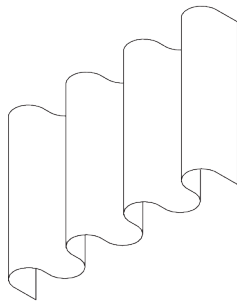

SG 11295

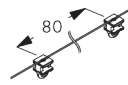

SG 11302

Standard components:

- SG 11295 End stop
- SG 11302 Wave 2C glider cord 80 mm



SG 2255



SG 2256

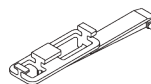

SG 6364



SG 6365

Optional components (min. radius >25 cm):

- SG 2255 Brake
- SG 2256 Brake
- SG 6364 Wave extension
- SG 6365 Wave hanger
- SG 6366 Wave carrier for draw rod
- SG 10430-34 Draw rod
- SG 11303 Wave 2C glider cord 60 mm

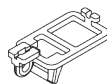

SG 6366

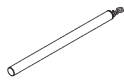

SG 10430-34

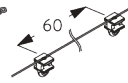

SG 11303



SG 3582

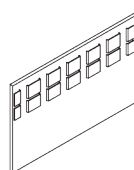

SG 6349

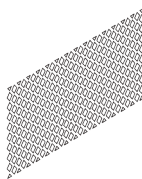

SG 6363

Curtain components:

- SG 3582 Hook
- SG 6349 Wave curtain tape
- SG 6363 Wave top hemming tape
- SG 10075 Lead weight 50 gr/m
- SG 10076 Fabric weight

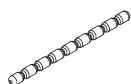

SG 10075



SG 10076

Wave stack depth - 2C glider cord (standard components)

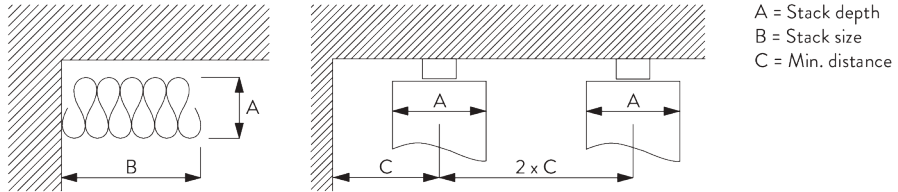





2C Glider cord SG 11302	Pockets between hooks	Approx. curtain fullness	Stack depth A	Stack size B*	Min distance C
80	6	~2.1	140	180 per metre of track	90
80	7	~2.3	160	180 per metre of track	100

2C Glider cord SG 11303	Pockets between hooks	Approx. curtain fullness	Stack depth A	Stack size B*	Min distance C
60	4	~2.1	100	230 per metre of track	70
60	5	~2.3	120	230 per metre of track	80



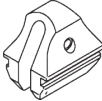



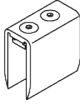
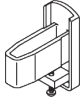



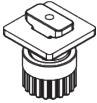

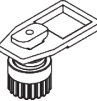
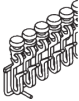

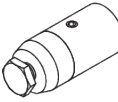
*Stack size B when using optional extension arm SG 6364 increases by 95 mm per curtain stack!

PARTS

A. STANDARD PARTS

	SG 6065 End stop
	SG 6086 Spring stop
	SG 6101 Profile
	SG 6143 Glider on strip
	SG 6190 Hanger
	SG 6610 Wall support
	SG 6611 End cover

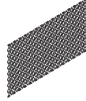
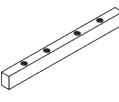
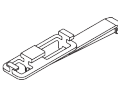
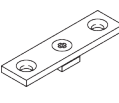
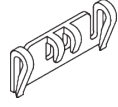
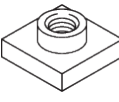
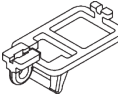
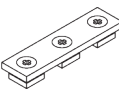
B. OPTIONAL PARTS

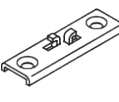
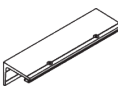
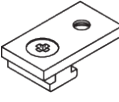
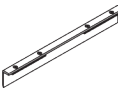
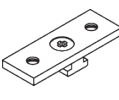
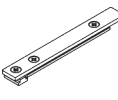
	SG 2255 Brake		SG 6146 Hook
	SG 2256 Brake		SG 6147 Glider with hook on strip
	SG 3582 Hook		SG 6175 Mini hanger
	SG 3599 Hook		SG 6187 Sleeve
	SG 6094 Roller		SG 6283 Roller
	SG 6098 Roller		SG 6349 Wave curtain tape
	SG 6110 Dust cover		SG 6363 Wave top hemming tape
	SG 6112 Connection bridge		SG 6364 Wave extension
	SG 6115 Bracket		SG 6365 Wave hanger
	SG 6117 Slot nut		SG 6366 Wave carrier for draw rod
	SG 6123 Connection plate		SG 6501 V-Hanger
	SG 6124 Bracket		SG 6503 Bracket
	SG 6137 Bracket		SG 6512 Connection bridge
	SG 6138 Bracket		SG 6514 T-Junction

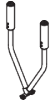

SG 6530

V-Hanger

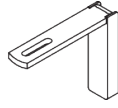

SG 11207

Smart Fix with slot 80 mm

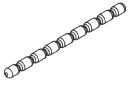

SG 10075

Lead weight 50 g/m

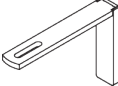

SG 11208

Smart Fix with slot 100 mm

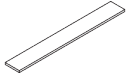

SG 10076

Fabric weight

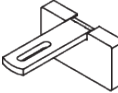

SG 11216

Square Smart Fix with slot 60 mm



SG 10430

Draw rod 50 cm

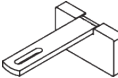

SG 11217

Square Smart Fix with slot 80 mm



SG 10431

Draw rod 75 cm

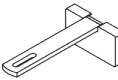

SG 11218

Square Smart Fix with slot 100 mm

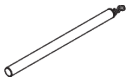

SG 10432

Draw rod 100 cm



SG 11295

End stop

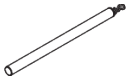

SG 10433

Draw rod 125 cm



SG 11302

Wave 2C glider cord 80 mm

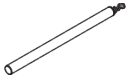

SG 10434

Draw rod 150 cm



SG 11303

Wave 2C glider cord 60 mm

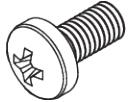

SG 10492

Pan head screw M4x8



SG 11131

Pan head screw with flange M4x6

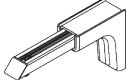

SG 11154

Universal Smart Fix 120 mm

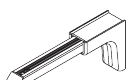

SG 11155

Universal Smart Fix 150 mm

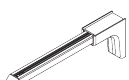

SG 11156

Universal Smart Fix 200 mm

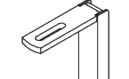

SG 11206

Smart Fix with slot 60 mm