

SG 1280

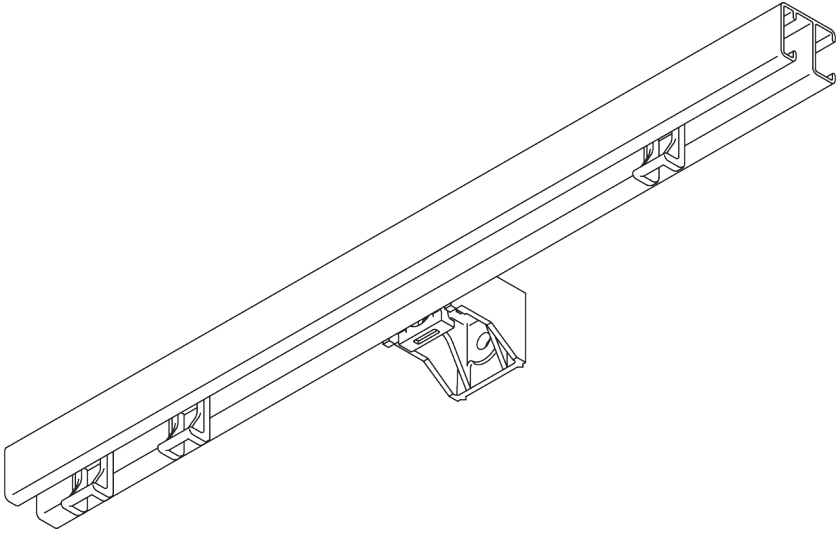

PRODUCT INFORMATION

- **Operation:** hand
- **Range:** M - L
- **Fitting:** ceiling, wall
- **Colours:** white RAL 9016; special colours or anodised aluminum possible
- **Fabrics:** refer to Silent Gliss fabric collection

Features:

- Bendable

SYSTEM SPECIFICATIONS

A. PROFILE

Profile and bending information

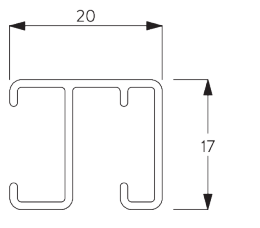

SG 1280p

Profile

Radius:
✓ 15 cm, 20 cm

B. HOW TO MEASURE

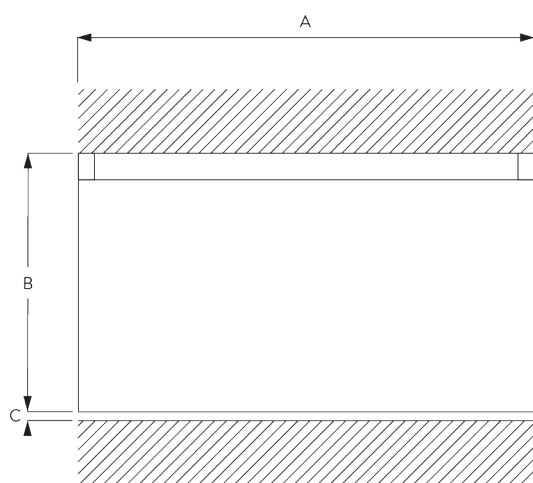

A: System width

B: System height

C: Distance between floor and fabric

C. SPECIFICATION TEXT

Silent Gliss SG 1280 Hand Operated Curtain Track System. Comprises aluminium profile SG 1280 supplied made to measure in powder coated white, with 2 end covers SG 3985. Face fixed with nylon bracket SG 3630 / SG 3655 / SG 3660 / SG Smart Fix / top fixed with nylon bracket 3603 at max. 600 mm centres.

FITTING

A. FITTING INFORMATION

Fixing Points

For detailed fitting information, visit the [Silent Gliss website](#).

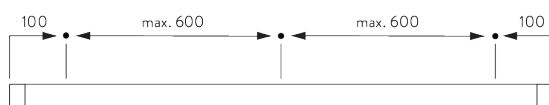

B. CEILING FITTING

Bracket SG 3603

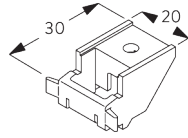
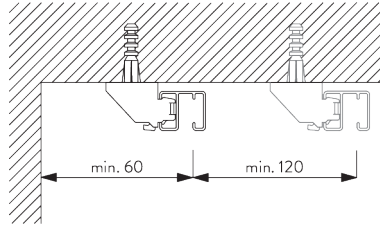

SG 3603
Bracket

C. WALL FITTING

Universal brackets SG 3630, SG 3655, SG 3660

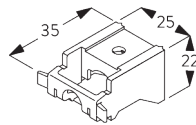
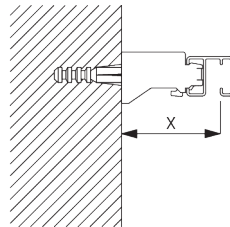

SG 3630
Bracket 35 mm

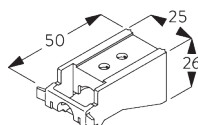

SG 3655
Bracket 50 mm

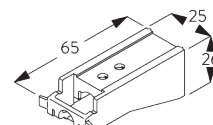

SG 3660
Bracket 65 mm

Bracket	X mm
SG 3630	42
SG 3655	57
SG 3660	72

Smart Fix

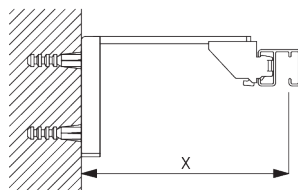

Smart Fix SG 11200 - SG 11204 and bracket SG 3603:
Screw SG 10492 (M4x8) needed.

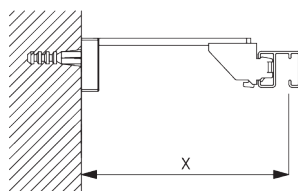

**Square Smart Fix SG 11210 - SG 11214 and
bracket SG 3603:**
Screw SG 10492 (M4x8) needed.

Smart Fix	X mm
SG 11200 / SG 11210	80
SG 11201 / SG 11211	100
SG 11202 / SG 11212	120
SG 11203 / SG 11213	140
SG 11204 / SG 11214	170
SG 11154	130-158
SG 11155	160-188
SG 11156	210-238

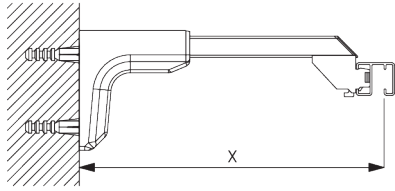

Universal Smart Fix SG 11154 - SG 11156 and bracket SG 3603:

Screw SG 10277 (M4x12) needed.

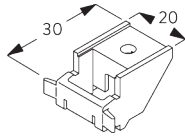

SG 3603

Bracket



SG 10277

Pan head screw M4x12



SG 10492

Pan head screw M4x8

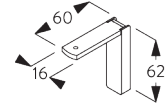

SG 11200

Smart Fix 60 mm

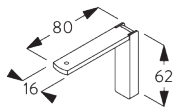

SG 11201

Smart Fix 80 mm

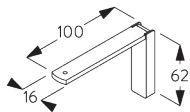

SG 11202

Smart Fix 100 mm

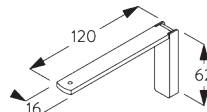

SG 11203

Smart Fix 120 mm

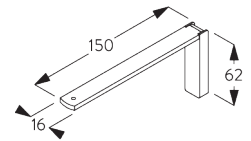

SG 11204

Smart Fix 150 mm

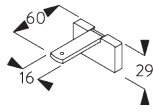

SG 11210

Square Smart Fix 60 mm

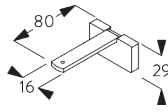

SG 11211

Square Smart Fix 80 mm

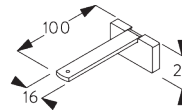

SG 11212

Square Smart Fix 100 mm

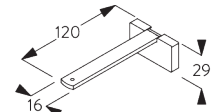

SG 11213

Square Smart Fix 120 mm

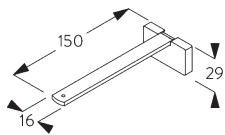

SG 11214

Square Smart Fix 150 mm

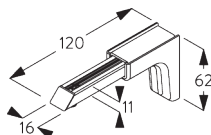

SG 11154

Universal Smart Fix 120 mm

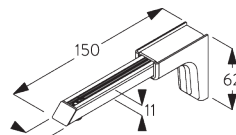

SG 11155

Universal Smart Fix 150 mm

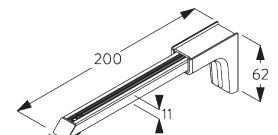

SG 11156

Universal Smart Fix 200 mm

PARTS

A. STANDARD PARTS

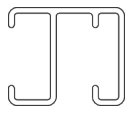

SG 1280p

Profile

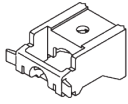

SG 3630

Bracket 35 mm



SG 3911

Roller

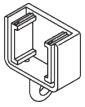

SG 3985

End cover

B. OPTIONAL PARTS



SG 3582

Hook



SG 3599

Hook

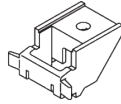

SG 3603

Bracket

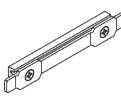

SG 3620

Connection bridge

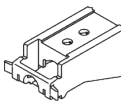

SG 3655

Bracket 50 mm

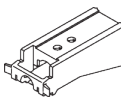

SG 3660

Bracket 65 mm

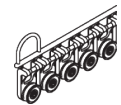

SG 3922

Roller 3911 on strip

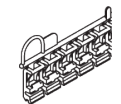

SG 3933

Glider 3933 on strip

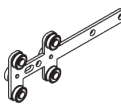

SG 3935

Overlap arm

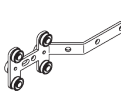

SG 3936

Overlap arm for draw rod



SG 3942

End stop

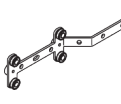

SG 3975

Overlap arm

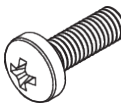

SG 10277

Pan head screw M4x12

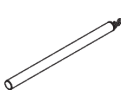

SG 10430

Draw rod 50 cm

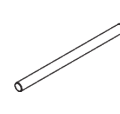

SG 10431

Draw rod 75 cm

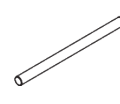

SG 10432

Draw rod 100 cm

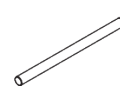

SG 10433

Draw rod 125 cm

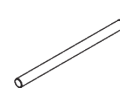

SG 10434

Draw rod 150 cm

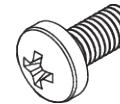

SG 10492

Pan head screw M4x8

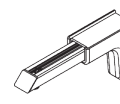

SG 11154

Universal Smart Fix 120 mm

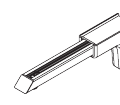

SG 11155

Universal Smart Fix 150 mm



SG 11156

Universal Smart Fix 200 mm

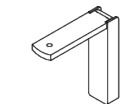

SG 11200

Smart Fix 60 mm

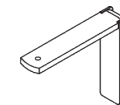

SG 11201

Smart Fix 80 mm

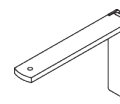

SG 11202

Smart Fix 100 mm

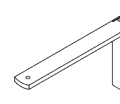

SG 11203

Smart Fix 120 mm

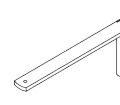

SG 11204

Smart Fix 150 mm

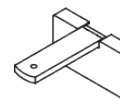

SG 11210

Square Smart Fix 60 mm

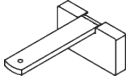

SG 11211

Square Smart Fix 80 mm

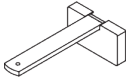

SG 11212

Square Smart Fix 100 mm

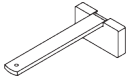

SG 11213

Square Smart Fix 120 mm

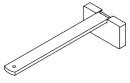

SG 11214

Square Smart Fix 150 mm
