

# SG 6290

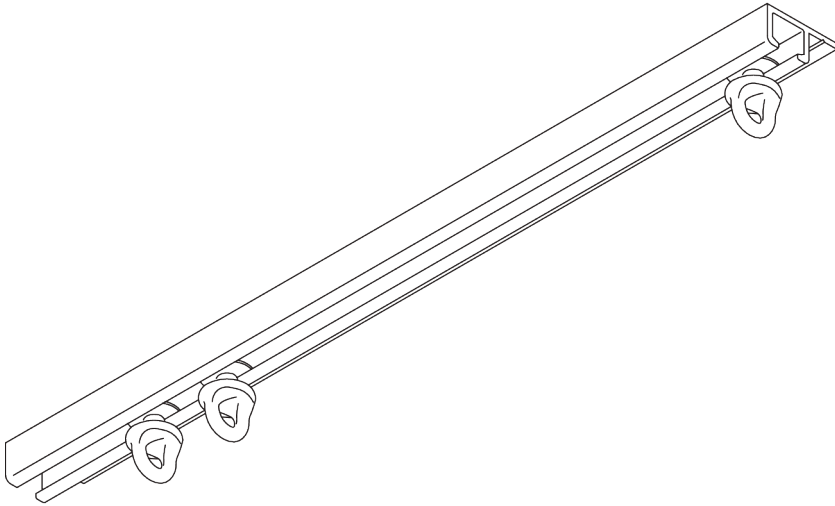

## SAFETY TRACK



### PRODUCT INFORMATION

- **Operation:** hand
- **Range:** S - M
- **Fitting:** ceiling
- **Colours:** white RAL 9016; special colours or anodised aluminum possible
- **Fabrics:** refer to Silent Gliss fabric collection

#### **Features:**

- Suitable for schools, hospitals, retirement homes, etc.
- Yellow gliders release from profile when weight limit is exceeded (4 - 6 kg)
- Blue glider releases at higher weight limit (8 - 10 kg) due to higher pulling force at curtain leading edges

# SYSTEM SPECIFICATIONS

## A. PROFILE

Profile information

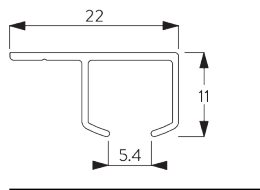

SG 6290p

Profile

## B. HOW TO MEASURE

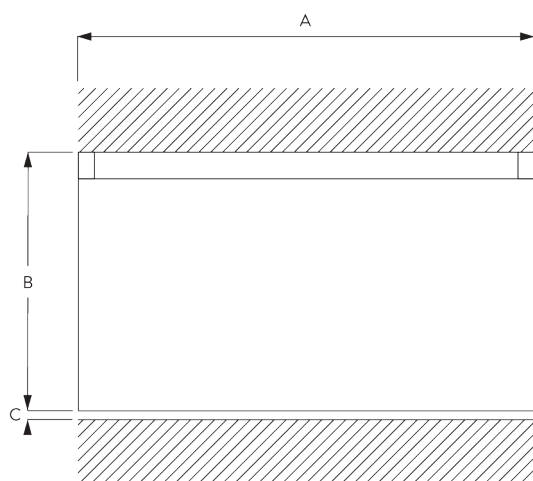

A: System width

B: System height

C: Distance between floor and fabric

## C. SPECIFICATION TEXT

**Silent Gliss SG 6290 Hand Operated Curtain Track.** Comprises aluminium SG 6290 profile supplied made to measure powder coated white with safety gliders SG 6148 (10/m) and SG 6149 (2/length) secured with end covers SG 6122 at either end. Ceiling fixed with self-drilling wood screws.

# FITTING

## A. FITTING INFORMATION

Fixing points

For detailed fitting information, visit the [Silent Gliss website](#).

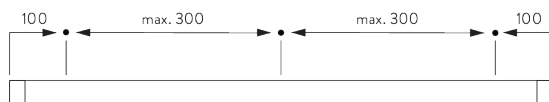

## B. CEILING FITTING

Direct fitting

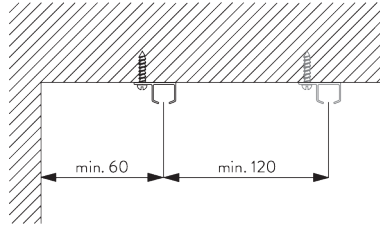

# SYSTEM SAFETY KEY PARTS

## A. SAFETY RELEASE FUNCTION

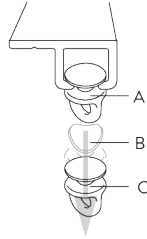

A: Gliders can easily be clicked into profile

B: Glider deforms under pressure

C: Release under following pull weights:

Glider SG 6148 yellow: releases between 4 - 6 kg

Glider SG 6149 blue: releases between 8 - 10 kg

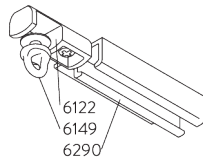

SG 6122: Endstop (with end glider SG 6148 in place)

SG 6021 / SG 6290 system can assist in the prevention of self harm in hospitals, schools and psychiatric situations. Please see specific pull out weights on individual gliders. Please also note that the longer the individual track and the more gliders used, the cumulative total pull-out weight when in a stacked position will increase and therefore support more weight.

**A risk assessment of the area should always be carried out.**

# PARTS

## A. STANDARD PARTS

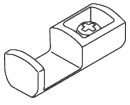

**SG 6122**

End stop



**SG 6148**

Safety Glider - yellow



**SG 6149**

Safety glider - blue

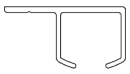

**SG 6290p**

Profile

## B. OPTIONAL PARTS



**SG 3582**

Hook



**SG 3599**

Hook

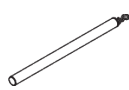

**SG 10430**

Draw rod 50 cm

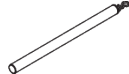

**SG 10431**

Draw rod 75 cm

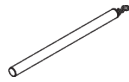

**SG 10432**

Draw rod 100 cm

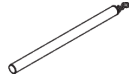

**SG 10433**

Draw rod 125 cm

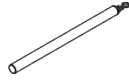

**SG 10434**

Draw rod 150 cm