

SG 1003M

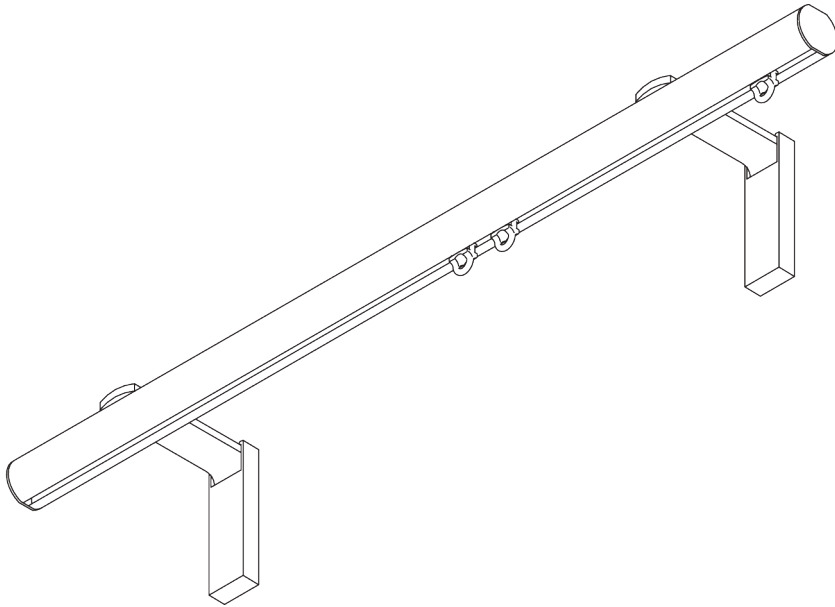
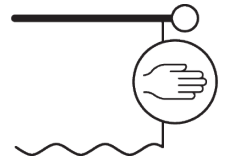

PRODUCT INFORMATION

- **Operation:** hand
- **Range:** S
- **Fitting:** ceiling, wall
- **Colours:** white RAL 9016, various colours / finishes
- **Fabrics:** refer to Silent Gliss fabric collection

Features:

- Matching endcaps and brackets / bracket covers
- Range of decorative finials
- Bendable

SYSTEM SPECIFICATIONS

A. PROFILE

Profile and bending information

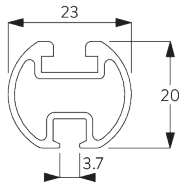

SG 1003p

Profile



B. HOW TO MEASURE

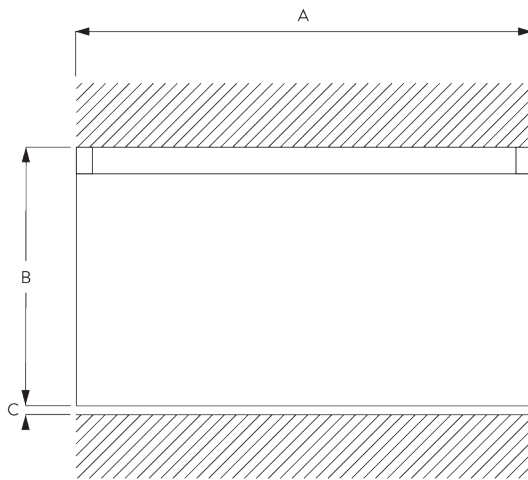

A: System width includes finials

B: System height

C: Distance between floor and fabric

C. SPECIFICATION

TEXT

Silent Gliss SG 1003 'Metropole' hand operated curtain track system. Comprises 23mm round aluminium profile SG 1003 supplied made to measure with gliders SG 3533 at 16/m, 2no. end stops SG 3070 and 2 no. flush end covers SG 20339. Straight poles supplied as standard with wall 'face' fix Smart Fix brackets SG 11206 at max. 600mm centres. Optional wall fix brackets SG 11207-11208 / SG 11216-11218 / SG 11209 / Maxi bracket SG 20334 / Blok bracket SG 20989. Bent systems for wall 'face' fix supplied as standard with adjustable Smart Fix bracket SG 11209. Ceiling 'top' fix with bracket SG 6151 / SG 20335 at max. 600mm centres. Finished in White, Matt White, Ecru, Silver Anodised, Gunmetal, Charcoal and Chrome Effect. A range of decorative finials are available.

FITTING

A. FITTING INFORMATION

Fixing points

For detailed fitting information, visit the [Silent Gliss website](#).

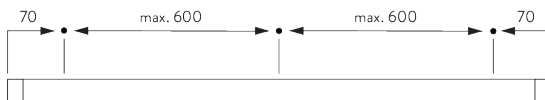

B. CEILING FITTING

Support SG 6151

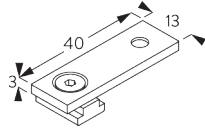
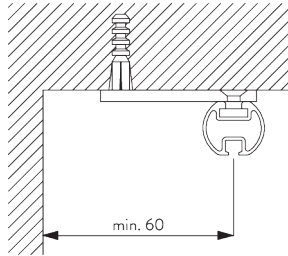

SG 6151

Ceiling support set 3 mm

Top fix bracket SG 20335

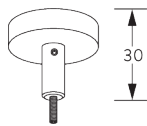
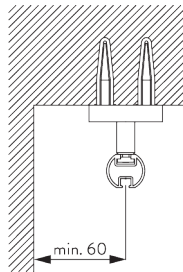

SG 20335

Top fix bracket

C. WALL FITTING

Smart Fix

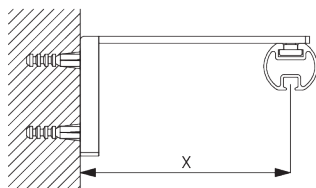

Smart Fix with slot SG 11206 - SG 11208 and SG 6141:
Screw SG 20798 (M4x10) needed.

Smart Fix	X mm
SG 11206 / SG 11216	51
SG 11207 / SG 11217	71
SG 11208 / SG 11218	91
SG 11209 / SG 11472	80-100

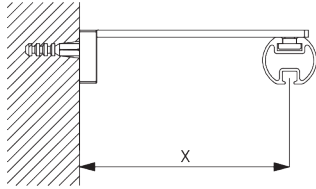

Square Smart Fix with slot SG 11216 - SG 11218 and SG 6141:

Screw SG 20798 (M4x10) needed.

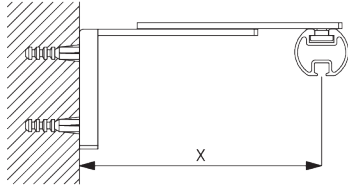

Adjustable Smart Fix SG 11209 and SG 6141:

Screw SG 20798 (M4x10) needed.

Note: all bent Metropole systems are supplied with adjustable bracket SG 11209 as standard.

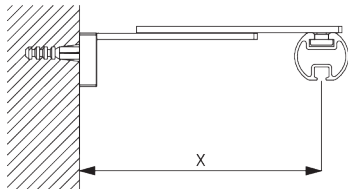

Adjustable Square Smart Fix SG 11472 and SG 6141:

Screw SG 20798 (M4x10) needed.

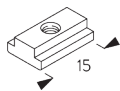

SG 6141

Clamping piece

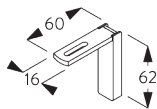

SG 11206

Smart Fix with slot 60 mm

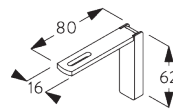

SG 11207

Smart Fix with slot 80 mm

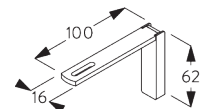

SG 11208

Smart Fix with slot 100 mm

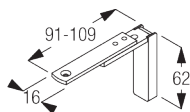

SG 11209

Adjustable Smart Fix

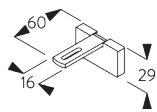

SG 11216

Square Smart Fix with slot 60 mm

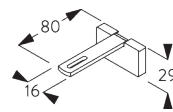

SG 11217

Square Smart Fix with slot 80 mm

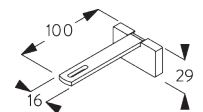

SG 11218

Square Smart Fix with slot 100 mm

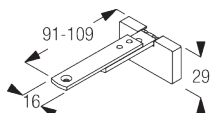

SG 11472

Adjustable Square Smart Fix



SG 20798

Hexagon socket countersunk screw M4x10 mm

**Blok bracket
SG 20989**

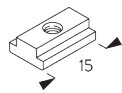
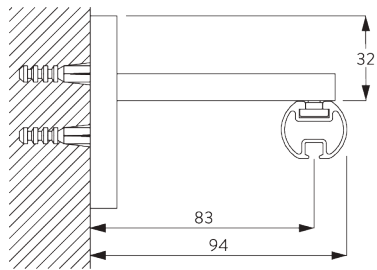

SG 6141
Clamping piece

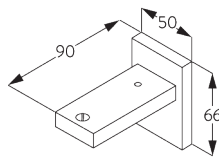

SG 20989
Blok bracket

DESIGN OPTIONS

A. ENDCAPS

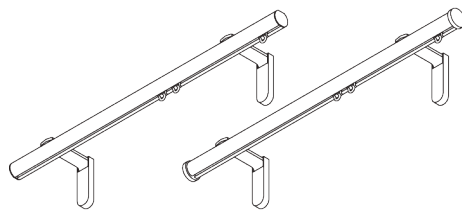

Without finials, poles are supplied as standard with flush fitting endcaps SG 20339 (left).

Alternatively, stud endcaps SG 20706 (right) can be selected at no additional cost.

B. FINIALS

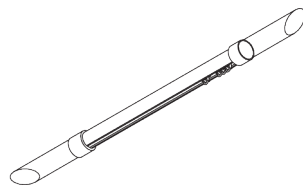

Finials are decorative elements that fit on at the end of the pole.

Please refer to the *Metropole brochure* for full range details.

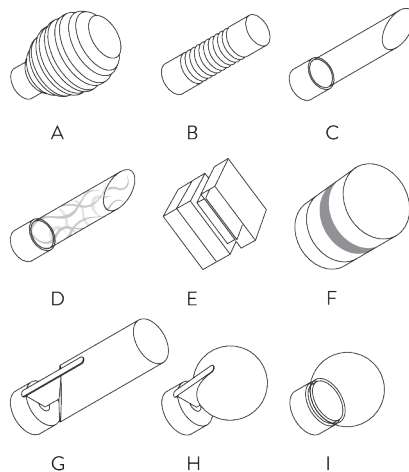

- A: SG 20985 Groove Ball 85 mm
- B: SG 20628 Groove Cylinder 80 mm
- C: SG 20993 Shard (clear) 112 mm
- D: SG 20993 Shard (etched) 112 mm
- E: SG 20884 Crystal Cube 33 mm
(green, black, brown)
- F: SG 20894 Crystal Cylinder 55 mm
(green, black, brown)
- G: SG 20308 Fused Barrel 90 mm
(walnut, oak, colour matched)
- H: SG 20321 Fused Ball 48 mm
(walnut, oak, colour matched)
- I: SG 20329 Glass Ball 45 mm
(clear, frosted)

GENERAL NOTES

Dimensions

- Measurements are in mm except where indicated.
- Max. kg relates to fabric incl. accessories.
- Stack size depends on curtain make-up and fabric thickness.
- Distance between gliders max. 80 mm / distance between rollers max. 100 mm.
- Recommended distance floor / fabric: 20 mm.
- In order to determine system height (B), the smallest room height must be taken into account.

Fitting





- Installation by qualified fitter only.
- Number of brackets and fitting positions / fixing points vary depending on fitting surface, system weight, fabric make-up, screw / fixing type and obstacles.
- Qualified fitter must use appropriate screws / fixings for each situation.
- Profile lip if applicable to be installed to room side.

Child Safety





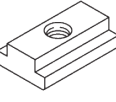
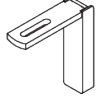

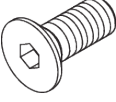
- All relevant Silent Gliss systems correspond to child safety EN 13120.
- All parties involved must comply with EN 13120.

PARTS

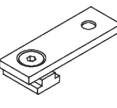
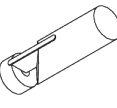
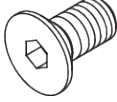
A. STANDARD PARTS

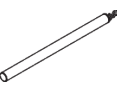
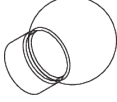
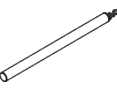
	SG 1003p Profile
	SG 3070 End stop
	SG 3534 Glider 3533 on strip
	SG 6141 Clamping piece
	SG 11206 Smart Fix with slot 60 mm
	SG 20339 Flush endcap 23 mm
	SG 20798 Hexagon socket countersunk screw M4x10 mm

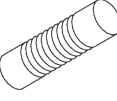
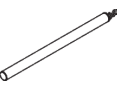
B. OPTIONAL PARTS

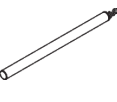
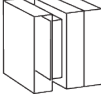
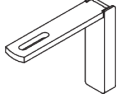
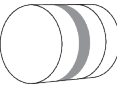
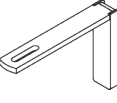
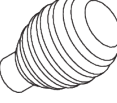
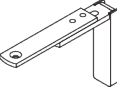
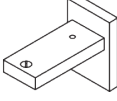
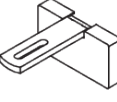
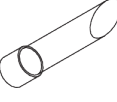
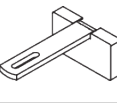
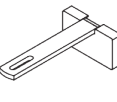
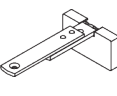
	SG 6151 Ceiling support set 3 mm		SG 20308 Fused barell 90 mm
	SG 6784 Hexagon socket countersunk screw M4x8 mm		SG 20321 Fused ball 48 mm
	SG 10430 Draw rod 50 cm		SG 20329 Glass ball 45 mm
	SG 10431 Draw rod 75 cm		SG 20335 Top fix bracket
	SG 10432 Draw rod 100 cm		SG 20628 Groove cylinder 80 mm
	SG 10433 Draw rod 125 cm		SG 20706 Stud endcap 23 mm
	SG 10434 Draw rod 150 cm		SG 20884 Crystal cube 33 mm
	SG 11207 Smart Fix with slot 80 mm		SG 20894 Crystal cylinder 55 mm
	SG 11208 Smart Fix with slot 100 mm		SG 20985 Groove ball 85 mm
	SG 11209 Adjustable Smart Fix		SG 20989 Blok bracket
	SG 11216 Square Smart Fix with slot 60 mm		SG 20993 Shared glass 112 mm
	SG 11217 Square Smart Fix with slot 80 mm		
	SG 11218 Square Smart Fix with slot 100 mm		
	SG 11472 Adjustable Square Smart Fix		

