

SG 4960

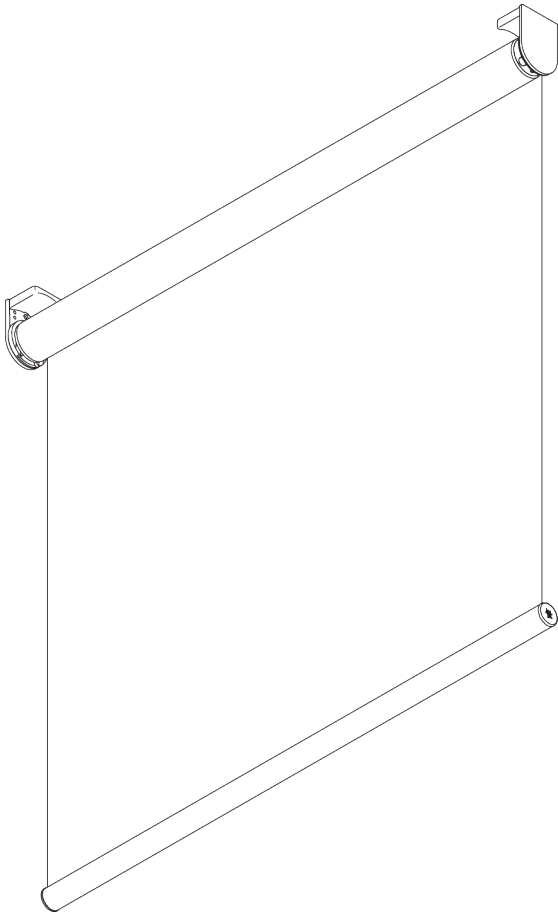
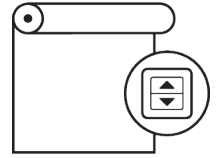

PRODUCT INFORMATION

- **Operation:** motorised
- **Range:** S - M
- **Fitting:** ceiling, wall, recess
- **Colours:** white RAL 9016, grey RAL 7035, black RAL 9005; special colours possible
- **Fabrics:** refer to Silent Gliss fabric collection

Features:

- Quiet and fast motors, soft stop
- Various control options
- Two connected systems
- Click-in brackets
- Fascia, box, installation profile

03/2026/V1

SYSTEM SPECIFICATIONS

A. SYSTEM DIMENSIONS

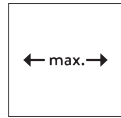

Single system: 2.4 m
Double system: 4.8 m

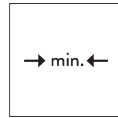

61 cm*
*see motor specification table

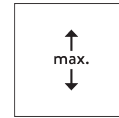

4 m



Single system: 9.6 m²
Double system: 19.2 m²



5.5 kg

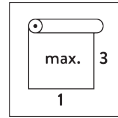

Recommended width /
height ratio
max. 1:3

Maximum system drop

Wall fitting (system drop on window side)

Fabric thickness	mm	0.15	0.20	0.25	0.30	0.35	0.40	0.45	0.50	0.55	0.60	0.65	0.70	0.75	0.80
Max. system drop	cm	400	400	400	400	400	400	390	350	320	290	270	250	230	220

Ceiling fitting / wall fitting (system drop on room side)

Fabric thickness	mm	0.15	0.20	0.25	0.30	0.35	0.40	0.45	0.50	0.55	0.60	0.65	0.70	0.75	0.80
Max. system drop	cm	400	400	400	400	400	400	400	400	400	380	350	330	300	280

B. PROFILE

Profile information

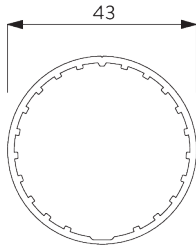

SG 10532
Tube ø 43 mm

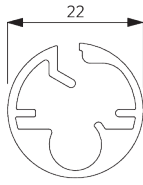

SG 10760
Bottom bar

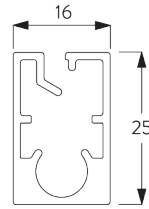

SG 10770
Bottom bar

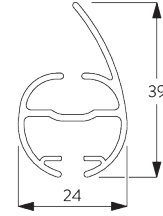

SG 4903
Bottom bar

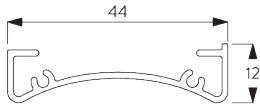

SG 10534
Installation profile

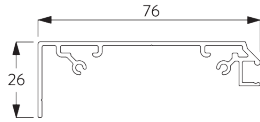

SG 11430
Installation profile fascia 73 mm

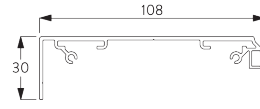

SG 11530
Installation profile fascia 110 mm

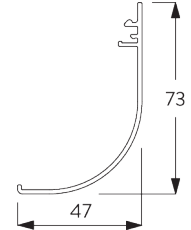

SG 11431
Fascia round 73 mm

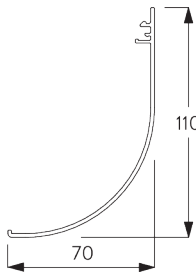

SG 11531
Fascia round 110 mm

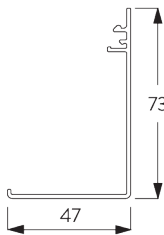

SG 11432
Fascia square 73 mm

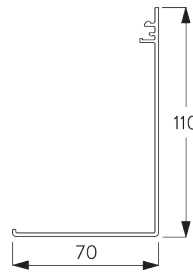

SG 11532
Fascia square 110 mm

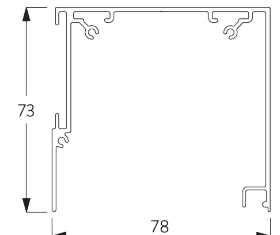

SG 11433
Box case 73 mm

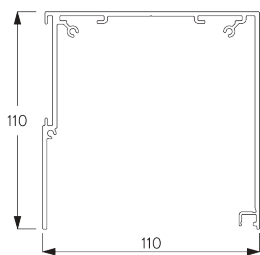

SG 11533
Box case 110 mm

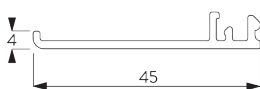

SG 11434
Box cover

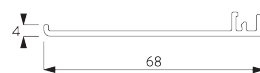

SG 11534
Box cover 110 mm

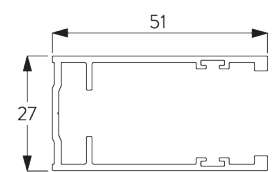

SG 11542
Side guide channel

**C. HOW TO
MEASURE**

incl. bracket covers

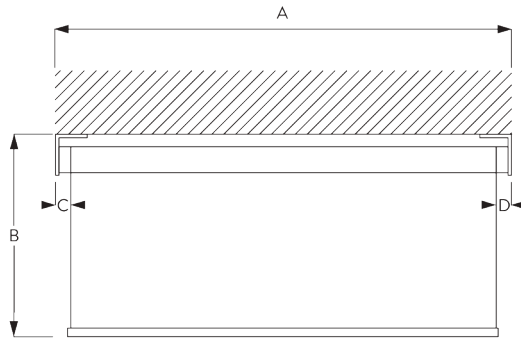

- A: System width
- B: System height
- C: Light gap: 13 mm
- D: Light gap operation side: 19 mm

Note:
Different light gaps see motor specifications.
All measurements include 2 mm for bracket cover per side!
These can be omitted to reduce side light gaps.

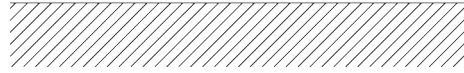

Fascia / Box

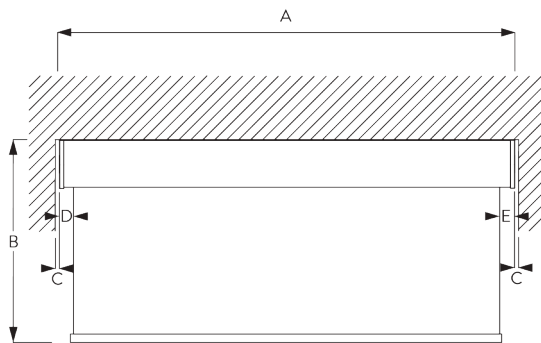

- A: System width
- B: System height
- C: Gap: min. 10 mm (when cover is used)*
- D: Light gap: 15 mm
- E: Light gap operation side: 21 mm

Note:
Different light gaps see motor specifications.
*Possible to make Fascia wider than system to reduce gap between wall and system.

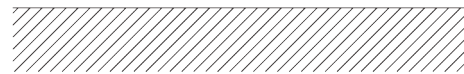

Fascia / Box with Side Profiles SG 11542

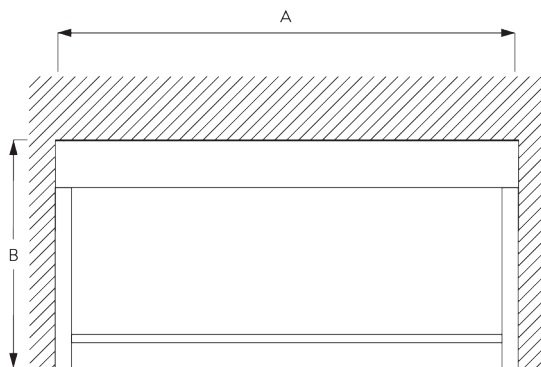

- A: System width
- B: System height

D. SPECIFICATION

TEXT

Silent Gliss SG 4960 Electrically Operated Roller Blind with Series 50 Smart by Silent Gliss enabled motor. Roller blind system for medium to large size blind applications up to 2.4m wide. Supplied made to measure and assembled comprising anodised aluminium barrel SG 10532. Fix to wall/ceiling/inside recess with brackets SG 10542/SG10543 and bracket covers SG 10574/SG 10575. Bottom bar [SG 10760 round / SG 10770 square / SG 4903 oval]. Visible metal hardware powder coated in [white / black / grey]. Integral 24V DC powered Smart by Silent Gliss motor SG 11250 positioned [left / right] side. Operation only via Silent Gliss Smart Gateway and associated components in conjunction with compatible third-party control systems. All wiring to be strictly in accordance with Silent Gliss wiring diagrams. Fabric to be chosen from The Collection by Silent Gliss, Price Group [1R / 2R / 3R].

Silent Gliss SG 4960 Electrically Operated Roller Blind System with SG Series 40 motor. Roller blind system for medium to large size blind applications up to 2.4m wide. Supplied made to measure and assembled comprising anodised aluminium barrel SG 10532. Fix to wall/ceiling/inside recess with brackets SG 10542/SG10543 and bracket covers SG 10574/SG 10575. Bottom bar [SG 10760 round / SG 10770 square / SG 4903 oval]. Visible metal hardware powder coated in [white / black / grey]. Integral motor [SG 11243 24V DC powered motor transformer not included / SG 11240 100-240 V AC 50/60Hz] positioned [left / right] side. Operation by [3rd party dry contact switching / 3rd party control system with suitable interface / Silent Gliss Control N radio controls via integrated receiver. Control N transmitter components supplied at additional cost. All wiring to be strictly in accordance with Silent Gliss wiring diagrams. Fabric to be chosen from The Collection by Silent Gliss, Price Group [1R / 2R / 3R].

Silent Gliss SG 4960 Electrically Operated Roller Blind System with SG Series 20 motor. Roller blind system for medium to large size blind applications up to 2.4m wide. Supplied made to measure and assembled comprising anodised aluminium barrel SG 10532. Fix to wall/ceiling/inside recess with brackets SG 10542/SG10543 and bracket covers SG 10574/SG 10575. Bottom bar [SG 10760 round / SG 10770 square / SG 4903 oval]. Visible metal hardware powder coated in [white / black / grey]. Integral motor SG 10320 230v 50 Hz mains switched motor positioned [left / right] side. Operation by [3rd party switching / SG Control R with external receiver / 3rd party automation system with suitable interface]. Control R transmitter & external receiver components supplied at additional costs All wiring to be strictly in accordance with Silent Gliss wiring diagrams. Fabric to be chosen from The Collection by Silent Gliss, Price Group [1R / 2R / 3R].

FITTING

A. FITTING INFORMATION

Fixing points

For detailed fitting information, visit the [Silent Gliss website](#).



Brackets (wall / ceiling)

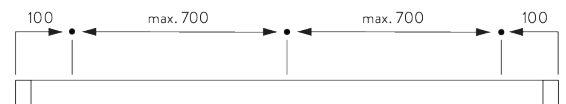

Fascia / box & installation profile SG 10534 (wall / ceiling)

B. CEILING FITTING

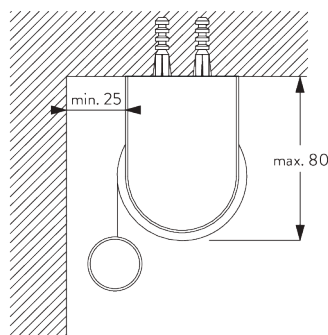

Brackets

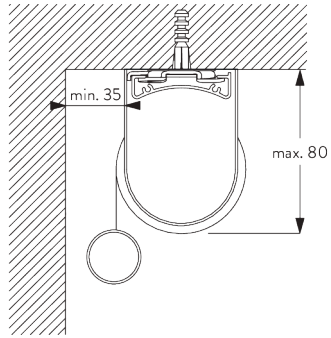

Installation profile SG 10534 and clamp SG 3044

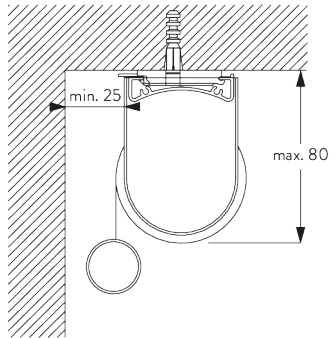

Installation profile SG 10534 and click bracket SG 10539
Not possible with two connected systems!

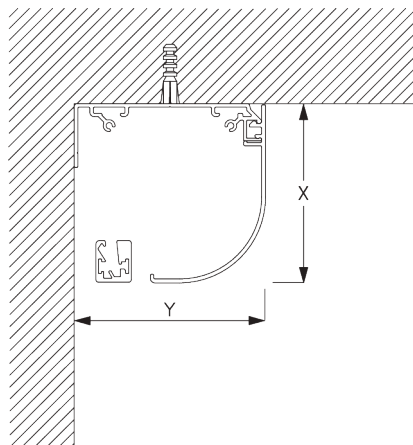

Fascia round
X = Fascia S 73 mm / Fascia L 110 mm
Y = Fascia S 78 mm / Fascia L 110 mm

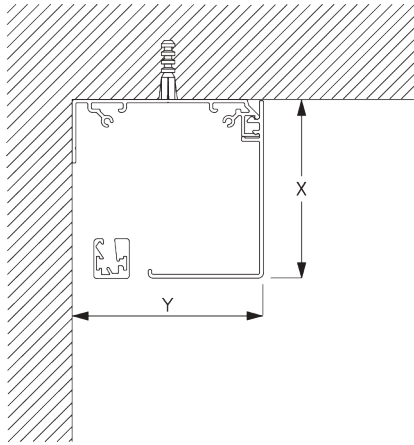

Fascia square

X = Fascia S 73 mm / Fascia L 110 mm

Y = Fascia S 78 mm / Fascia L 110 mm

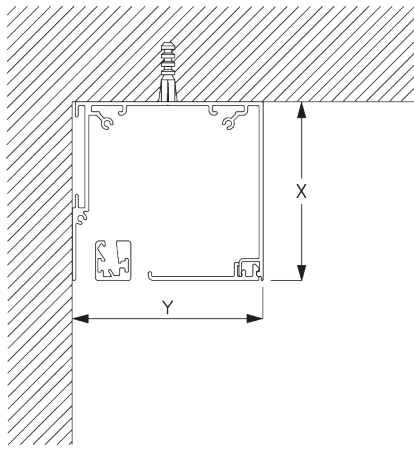

Box

X = Box S 73 mm / Box L 110 mm

Y = Box S 78 mm / Box L 110 mm

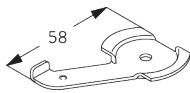

SG 3044

Clamp

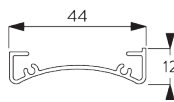

SG 10534

Installation profile

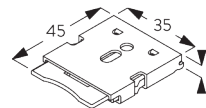

SG 10539

Bracket

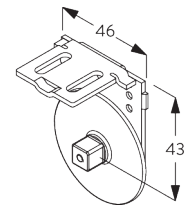

SG 10542

Bracket

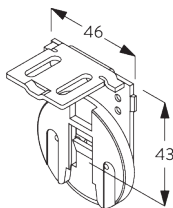

SG 10543

Bracket



SG 10574

Bracket cover

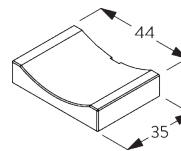

SG 10575

Bracket cover

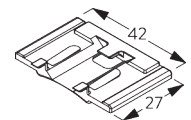

SG 10690

Spacer

C. WALL FITTING

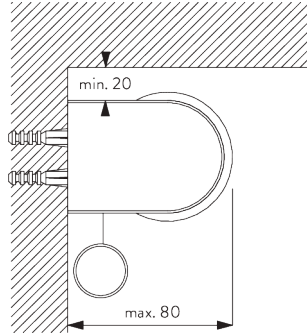

Brackets

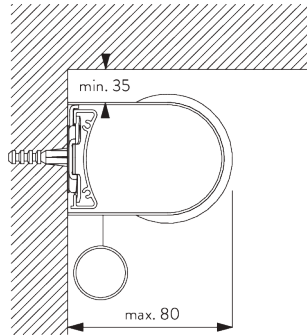

Installation profile SG 10534 and clamp SG 3044

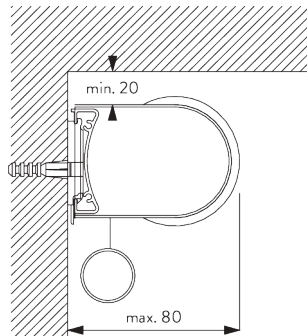

Installation profile SG 10534 and click bracket SG 10539
Not possible with two connected systems!

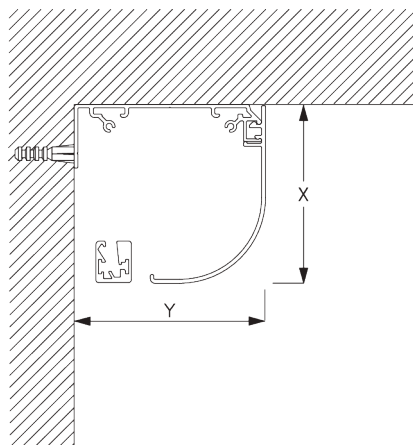

Fascia round
X = Fascia S 73 mm / Fascia L 110 mm
Y = Fascia S 78 mm / Fascia L 110 mm

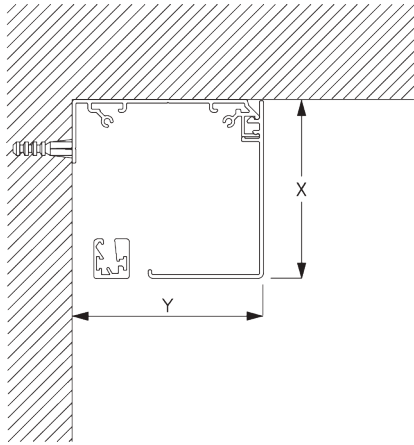

Fascia square

X = Fascia S 73 mm / Fascia L 110 mm

Y = Fascia S 78 mm / Fascia L 110 mm

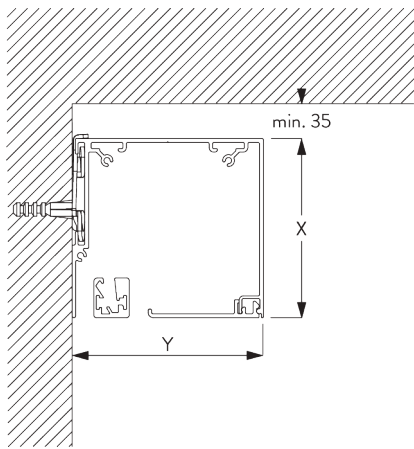

Box S and clamp SG 3044 / Box L and clamp SG 11180

X = Box S 73 mm / Box L 110 mm

Y = Box S 78 mm / Box L 110 mm

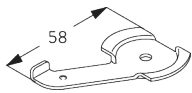

SG 3044

Clamp

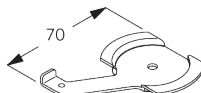

SG 11180

Clamp

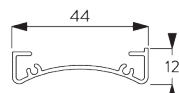

SG 10534

Installation profile

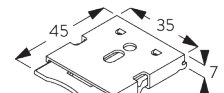

SG 10539

Bracket

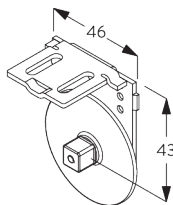

SG 10542

Bracket

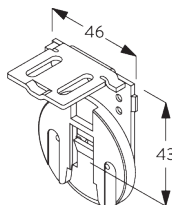

SG 10543

Bracket



SG 10574

Bracket cover

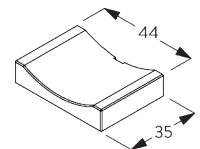

SG 10575

Bracket cover

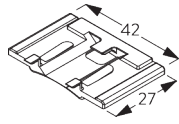

SG 10690

Spacer

D. RECESS FITTING

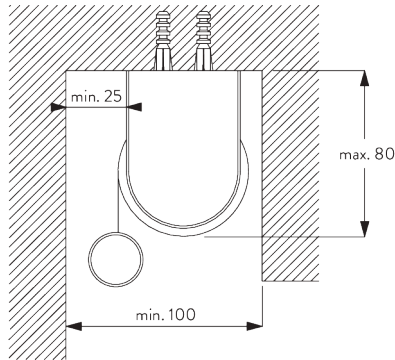

Brackets

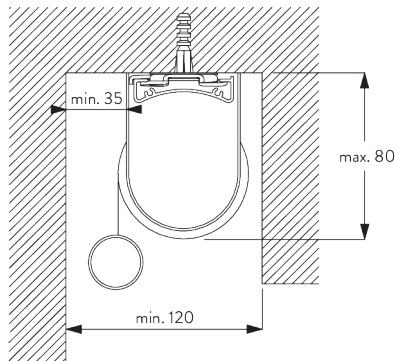

Installation profile SG 10534 and clamp SG 3044

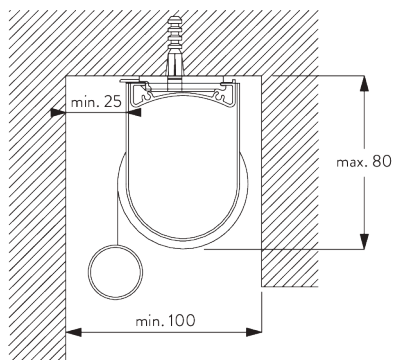

Installation profile SG 10534 and click bracket SG 10539

Not possible with two connected systems!

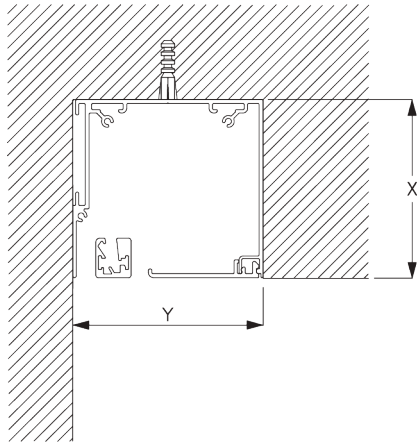

Box

X = Box S 73 mm / Box L 110 mm

Y = Box S min. 79 mm / Box L min. 111 mm

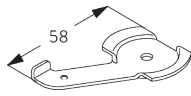

SG 3044
Clamp

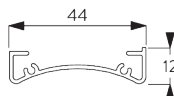

SG 10534
Installation profile

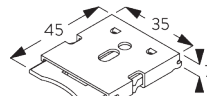

SG 10539
Bracket

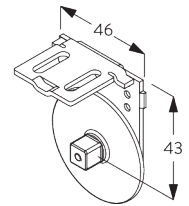

SG 10542
Bracket

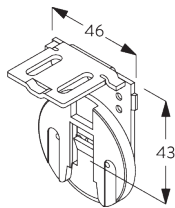

SG 10543
Bracket



SG 10574
Bracket cover

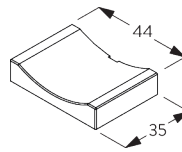

SG 10575
Bracket cover

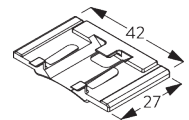

SG 10690
Spacer

**E. FITTING WITH
SIDE GUIDE
OPTION**

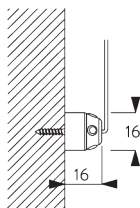
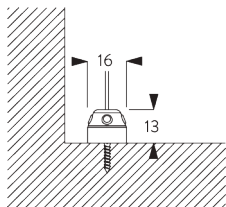

Single system

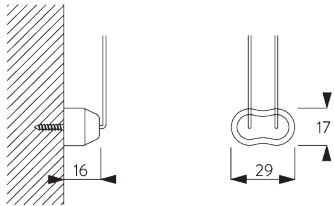
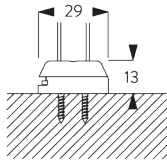

Double system (side-by-side installation)

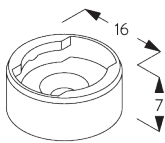

SG 8235
Side guide wire base short

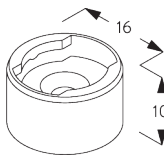

SG 8236
Side guide wire base long

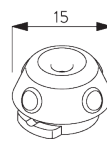

SG 8237
Side guide wire holder

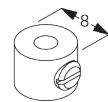

SG 8249
Side guide device

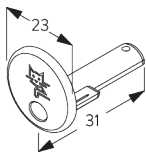

SG 10762
Side guide end cover

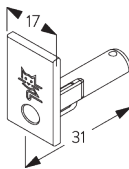

SG 10772
Side guide end cover

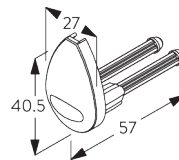

SG 4944
Side guide end cover

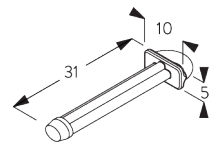

SG 10641
Side guide eyelet

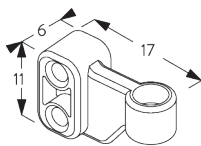

SG 10642
Side guide wire holder

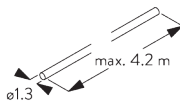

SG 10643
Side guide wire ø 1.3 mm x 4.2 m

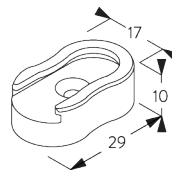

SG 10669
Side guide double base long

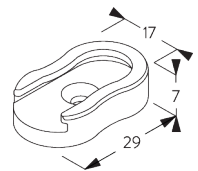

SG 10673
Side guide double base short

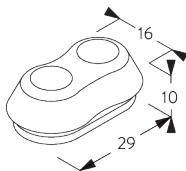

SG 10701
Side guide double wire holder

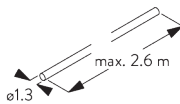

SG 10706
Side guide wire ø 1.3 mm x 2.6 m

SYSTEM OPTIONS

A. FABRIC ROLL-OFF

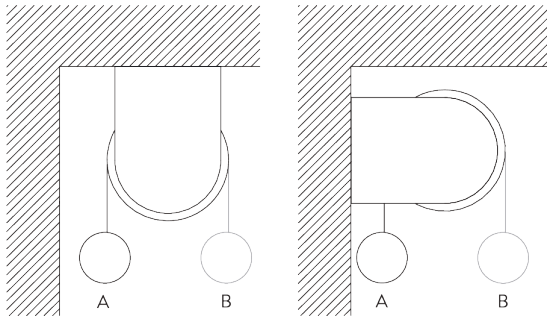

- A: Fabric roll-off window side (standard)
B: Fabric roll-off room side (option)

B. INSTALLATION PROFILE

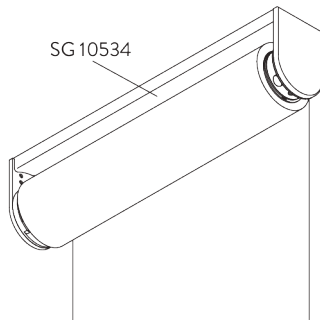

C. SIDE GUIDES

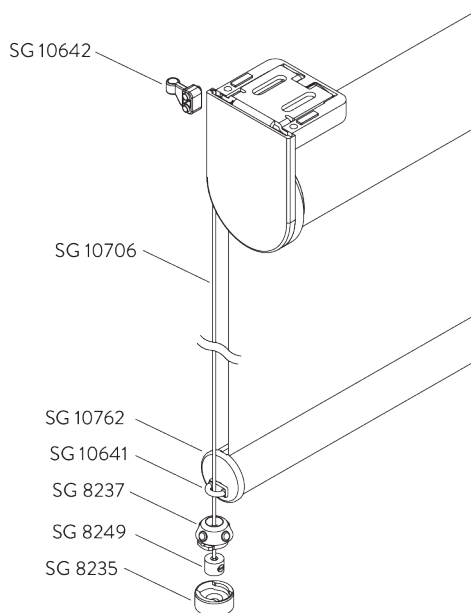

Additional parts:

- 2x SG 8235 Side guide wire base short
- 2x SG 8237 Side guide wire holder
- 2x SG 8249 Side guide device
- 2x SG 10762 Side guide end cover round
- 2x SG 10641 Side guide eyelet
- 2x SG 10642 Side guide wire holder
- 2x SG 10706 Side guide wire \varnothing 1.3 mm x 2.6 m

Optional parts:

- 2x SG 8236 Side guide wire base long
- 2x SG 10772 Side guide end cover square
- 2x SG 10643 Side guide wire \varnothing 1.3 mm x 4.2 m
- 1x SG 10669 Side guide double base long
- 1x SG 10673 Side guide double base short
- 1x SG 10701 Side guide double wire holder

Note:

- Light gaps increase when side-guide option is used
- Up to 15° from vertical

D. TWO CONNECTED SYSTEMS

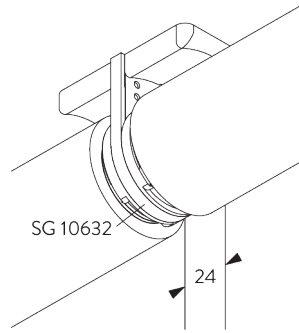

Additional parts:

- 1x SG 10558 Connection tube adapter
- 2x SG 10626 Connection bracket
- 2x SG 10627 Connection flange
- 1x SG 10628 Connection tube adapter
- 1x SG 10632 Connection bracket cover

E. TWO SINGLE SYSTEMS SIDE-BY-SIDE

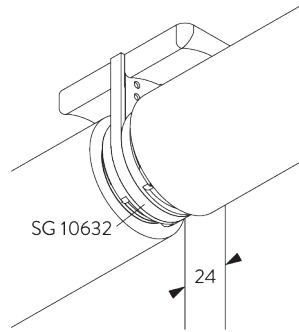

Additional parts:

- 1x SG 10632 Connection bracket cover

F. FASCIA / BOX

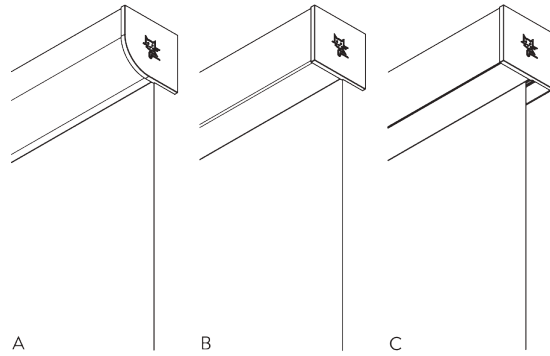

- A: Fascia round
- B: Fascia square
- C: Box

Size:

- S: 78 x 73 mm
- L: 110 x 110 mm

Note:

- Only applicable with bottom bar SG 11442
- Not possible with connected systems
- Two systems with one Fascia possible upon request

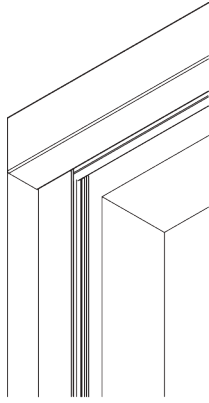

Optional side guide channels SG 11542 to be used with Fascia or Box.

Note:

- Only applicable with inside fitting
- Box: only recess fitting

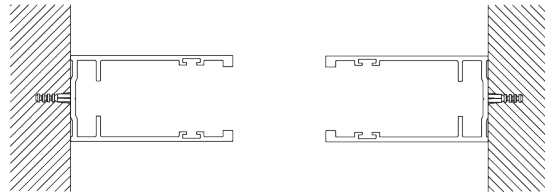

MOTORS & CONTROLS

A. MOTOR FEATURES

Motors	50-Series	40-Series	25-Series	20-Series
	SG 11250	SG 11941 SG 11942	SG 11625	SG 10320

Motor Features				
Soft stop	●	●	●	●
Electronic end-stop	●	●	●	●
Electronic revolution counter (unlimited revolution)	●	●	●	●
Mechanical end-stop				
Mechanical revolution counter (limited revolution)				
One intermediate position possible		●		
Bottom bar alignment	●	●	●*	
Noiseless stop				●
Parallel wiring possible without additional relays		●	●	●
Disconnectable motor cable	●	●	●	●
IP class	IP 30	IP 30	IP 30	IP 44

Control Features				
Mains power control			●	●
Dry contact control		●		
Dry contact and / or SG Control N control		●		
SG Control N (built-in receiver)		●		
SG Control R (external receiver required)			●	●
Smart by Silent Gliss	●			
Suitable for most major home automation systems (with suitable interface)		●	●	●

*Based on blinds the same size and fabric

B. MOTOR SPECIFICATIONS

Motors	Light gaps* C / D = driving side	Min. system width	Voltage	Current	Frequency	Speed	Frequency receiver
50-Series (Smart by Silent Gliss)							
SG 11250	C: 10 mm / D: 26 mm	56 cm	24 V DC	1.8 A	n/a	55 rpm	n/a
40-Series							
SG 11941	C: 10 mm / D: 26 mm	83 cm	100-240 V AC	0.3 A	50-60 Hz	55 rpm	433 MHz
SG 11942	C: 10 mm / D: 26 mm	56 cm	24 V DC	1.8 A	n/a	55 rpm	433 MHz
25-Series							
SG 11625	C: 10 mm / D: 26 mm	83 cm	100-240 V AC	0.8 A	50-60 Hz	32 rpm	n/a
20-Series							
SG 10320 (standard)	C: 13 mm / D: 19 mm	61 cm	230 V AC	0.55 A	50 Hz	70 rpm	n/a

*Light gaps Fascia or Box: C +2 mm / D +2 mm (40-/50-Series: C +3 mm / D + 2 mm)

C. OPERATING METHODS

See catalogue "controls" for details.

Wall Switch



System can be operated by fixed wall switch.

SG Control N



Various radio hand-held and wall transmitters available.



Silent Gliss Move App.

SG Control R



Various radio hand-held and wall transmitters available.
An external receiver is required.

Smart by Silent Gliss



Open designed two-way communication system which allows to flawlessly integrate products with most major building management systems.









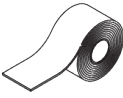
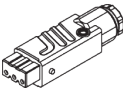

D. WIRING
DIAGRAMS

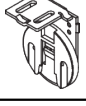
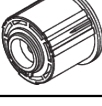

Refer to Silent Gliss website.

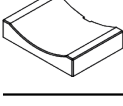
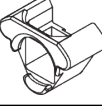



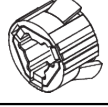

PARTS

A. STANDARD PARTS

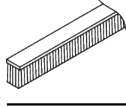
	SG 4226 Double tape 30 mm
	SG 9917 Hirschmann portable socket-outlet STAK 3 N
	SG 10284 O-Ring
	SG 10320 Tubular motor 230V AC, 20 Series 1.5/70
	SG 10532 Tube ø 43 mm
	SG 10542 Bracket
	SG 10543 Bracket
	SG 10557 Tube adapter
	SG 10574 Bracket cover
	SG 10575 Bracket cover
	SG 10620 Motor flange 10/20-Series
	SG 10621 Tube adapter
	SG 10668 PVC strip 10 mm
	SG 10760 Bottom bar

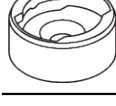
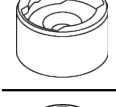
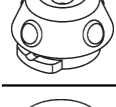
	SG 10761 End cover
	SG 11354 Motor drive 10/20-Series

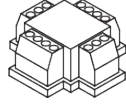
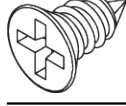
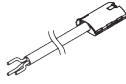
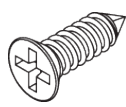
B. OPTIONAL PARTS

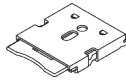
	SG 3044 Clamp
	SG 4508 Brush 5x7 mm
	SG 4903 Bottom bar
	SG 8235 Side guide wire base short
	SG 8236 Side guide wire base long
	SG 8237 Side guide wire holder
	SG 8249 Side guide device
	SG 9916 Hirschmann plug set
	SG 9959 Central control unit relay
	SG 10139 Countersunk screw 2.9x6.5
	SG 10293 Cable 230V AC, 2/3/5/10 m
	SG 10498 Countersunk screw 2.9x9.5
	SG 10534 Installation profile
	SG 10539 Bracket

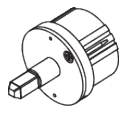

SG 10558
Connection tube adapter



SG 10701
Side guide double wire holder

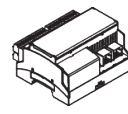

SG 11262
Expansion unit



SG 10622
Tube adapter, 24V DC motor

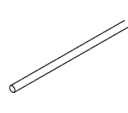

SG 10706
Side guide wire \varnothing 1.3 mm x 2.6 m

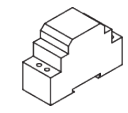

SG 11263
Power supply 24V DC, 2.5A DIN Rail

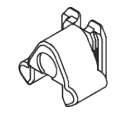

SG 10625
Motor flange, 10/20-Series



SG 10747
Motor plate S

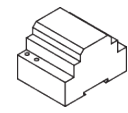

SG 11264
Power supply 24V DC, 3.8A DIN Rail

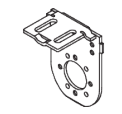

SG 10626
Connection bracket

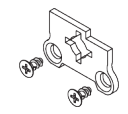

SG 10753
Motor plate

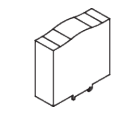

SG 11265
Power supply 24V DC, 5A DIN Rail



SG 10627
Connection flange



SG 10762
Side guide end cover

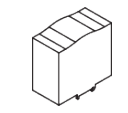

SG 11266
Power supply 24V DC, 10A DIN Rail



SG 10628
Connection tube adapter

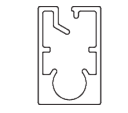

SG 10770
Bottom bar

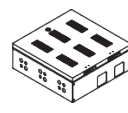

SG 11281
Cabinet for 8 systems



SG 10632
Connection bracket cover



SG 10771
End cover

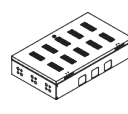

SG 11282
Cabinet for 24 systems

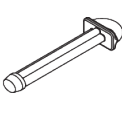

SG 10641
Side guide eyelet

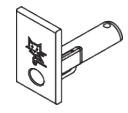

SG 10772
Side guide end cover

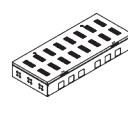

SG 11283
Cabinet for 56 systems

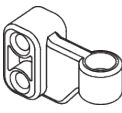

SG 10642
Side guide wire holder



SG 11178
End cover

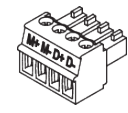

SG 11319
Plug 4-pin, MC 1.5/4-ST-3.81

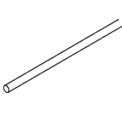

SG 10643
Side guide wire \varnothing 1.3 mm x 4.2 m



SG 11180
Clamp

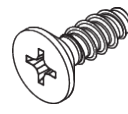

SG 11322
PT Screw Countersunk KA35x10 WN 1413



SG 10651
Connection flange



SG 11250
Motor 24V DC, 50-Series 1.5/55

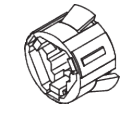

SG 11356
Motor drive 40/50-Series



SG 10669
Side guide double base long

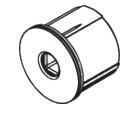

SG 11258
Tube adapter

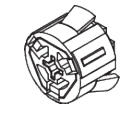

SG 11357
Motor drive Somfy 24 V DC



SG 10673
Side guide double base short

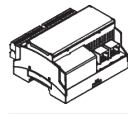

SG 11260
Gateway Cedia

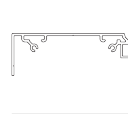

SG 11430
Installation profile fascia 73 mm

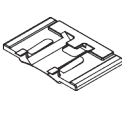



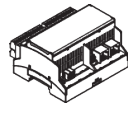









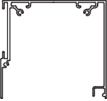

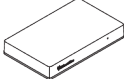

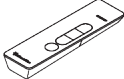

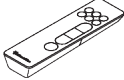



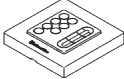







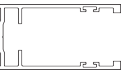
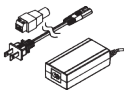

SG 10690
Spacer

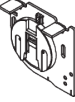

SG 11261
Gateway KNX

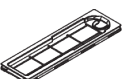

SG 11431
Fascia round 73 mm

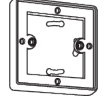
	SG 11432 Fascia square 73 mm		SG 11530 Installation profile fascia 110 mm		SG 11625 Motor 100-240V AC, 25-Series S 3/32
	SG 11433 Box case 73 mm		SG 11531 Fascia round 110 mm		SG 11900 Move Server
	SG 11434 Box cover		SG 11532 Fascia square 110 mm		SG 11931 Radio hand held 1 channel
	SG 11437 Bracket cover round left 73 mm		SG 11533 Box case 110 mm		SG 11932 Radio hand held 6 channel
	SG 11438 Bracket cover round right 73 mm		SG 11534 Box cover 110 mm		SG 11936 Radio wall transmitter 1 channel
	SG 11439 Bracket cover square left 73 mm		SG 11537 Bracket cover round left 110 mm		SG 11937 Radio wall transmitter 6 channel
	SG 11440 Bracket cover square right 73 mm		SG 11538 Bracket cover round right 110 mm		SG 11941 Motor 100-240V AC, 40-Series S 1.5/55, radio receiver
	SG 11442 Bottom bar		SG 11539 Bracket cover square left 110 mm		SG 11942 Motor 24V DC, 40-Series S 1.5/55, radio receiver
	SG 11443 End cover		SG 11540 Bracket cover square right 110 mm		SG 11966 Power supply set 24V/2A with GB plug
	SG 11446 Bracket left 73 mm		SG 11542 Side guide channel		SG 11967 Power supply set 24V/2A with US plug
	SG 11447 Bracket right 73 mm		SG 11546 Bracket left 110 mm		SG 20336 Hand held transmitter 8 channel
	SG 11448 Bracket left 73 mm		SG 11547 Bracket right 110 mm		SG 20913 Wall switch single channel
	SG 11449 Bracket right 73 mm		SG 11548 Bracket left 110 mm		SG 20914 Wall switch 8 channel
	SG 11460 Cover for Hirschmann plug		SG 11549 Bracket right 110 mm		SG 20917 Pattress box

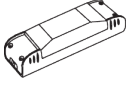

SG 20919

Control module motor type R
