

SG 8910

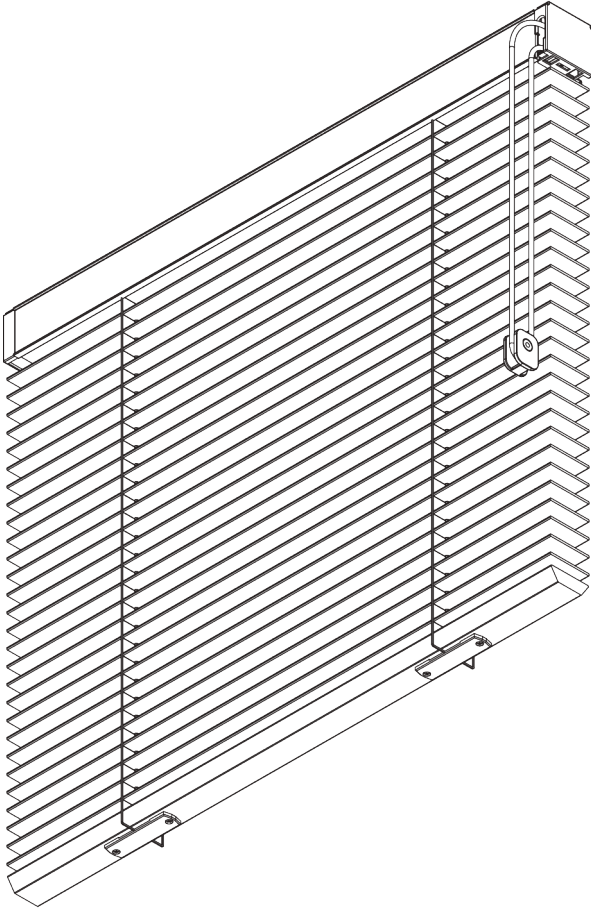
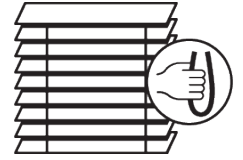

PRODUCT INFORMATION

- **Operation:** cord
- **Range:** L
- **Fitting:** ceiling, wall
- **Colours:** refer to Silent Gliss slat collection

Features:

- Optimised light control
- Speed controller: semi-automatic lowering of slats
- Wood, aluminium and leather slats
- Slat width: 50 mm
- Headrail slat cover
- Choice of ladder cord or decorative slat tape

04/2026/V2

SYSTEM SPECIFICATIONS

A. SYSTEM DIMENSIONS

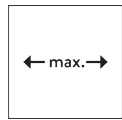

Wood / Leather: 2.4 m
Aluminium: 3.6 m

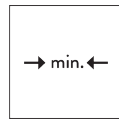

65 cm

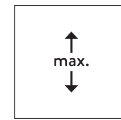

Wood / Leather: 2.75 m
Aluminium: 3.6 m



Wood / Leather: 4.6 m²
Aluminium: 10 m²

Slat stack heights

Note: stack size will be larger when tapes are used

Wooden

			60	90	120	150	180	210	240	275
50 mm	X		12	15	17	20	22	25	27	30

(cm)

Leather

			60	90	120	150	180	210	240	275
50 mm	X		14	16	18	20	22	24	26	28

(cm)

Aluminium

			100	200	300	360
50 mm	X		10	13	17	20

(cm)

B. PROFILE

Profile information

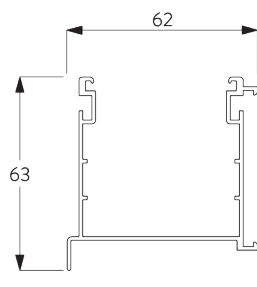

SG 8902

Profile

**C. HOW TO
MEASURE**

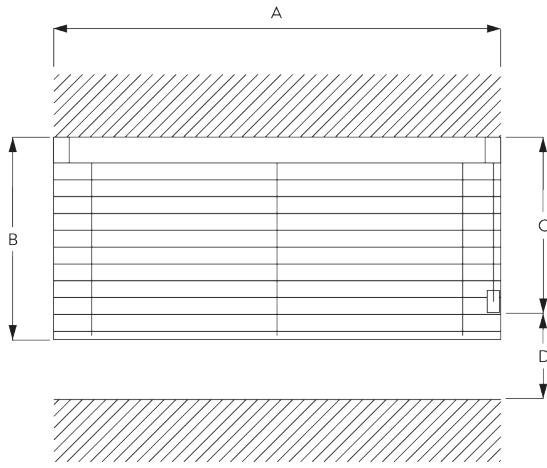

- A: System width
- B: System height
- C: Cord height
- D: Safety Retainer SG 10731 min. 150 cm above floor

**D. SPECIFICATION
TEXT**

Silent Gliss SG 8910 Cord Operated Venetian Blind System. Supplied made to measure and complete comprising aluminium headrail SG 8902 incorporating matching colour slat, right or left-hand side single cord operation which permits raising, lowering and tilting of the slats. System fixed with universal brackets SG 8920 to ceiling or wall at 500mm intervals plus one at 100mm from each end. Compliant to Child Safety legislation EN 13120 when used in conjunction with Cord Retainer 10400. Slat colours to be chosen from Silent Gliss 50mm aluminium / wood / leather range.

FITTING

**A. FITTING
INFORMATION**

For detailed fitting information, visit the Silent Gliss website.

Fixing points

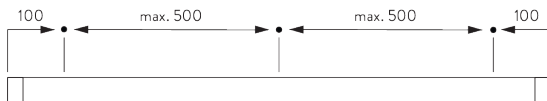

B. CEILING FITTING

Bracket SG 8920

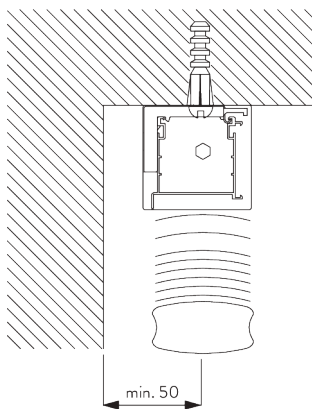

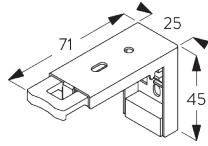

SG 8920
Bracket

C. WALL FITTING

Bracket SG 8920

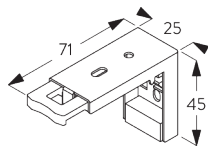
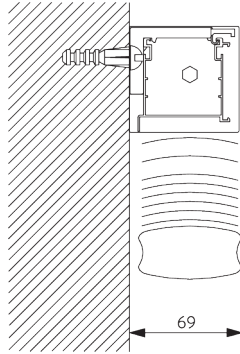

SG 8920
Bracket

**D. FITTING WITH
SIDE GUIDE
OPTION**

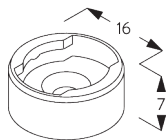
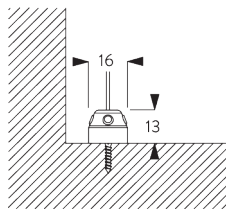

SG 8235
Side guide wire base short

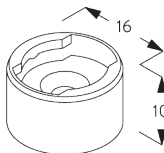

SG 8236
Side guide wire base long

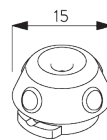

SG 8237
Side guide wire holder

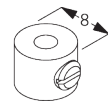

SG 8249
Side guide device

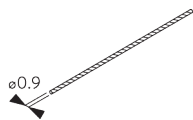

SG 10120
Side guide wire ϕ 0.9 mm

SYSTEM OPTIONS

A. HEADRAIL SLAT COVER

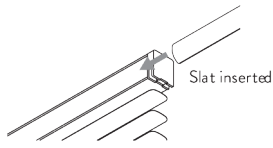

- A slat is inserted into the headrail for perfect matching of colours and materials to avoid the need to fit a cumbersome valance.
- For leather slat blinds there is the option of a leather covered headrail at an additional cost.
- Leather covered slats cannot be specified with decorative (external) slat tapes. The blind hardware is supplied matching the slat colour.

B. SIDE GUIDES

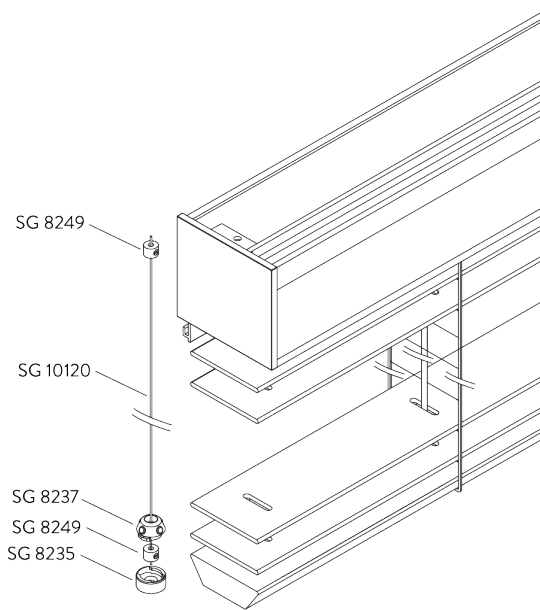

Additional parts:

- 2x SG 8235 Side guide wire base short
- 2x SG 8237 Side guide wire holder
- 4x SG 8249 Side guide device
- 2x SG 10120 Side guide wire \varnothing 0.9 mm

Note:

- Up to 15° from vertical

PARTS

A. STANDARD PARTS

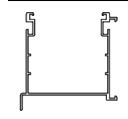

SG 8902

Profile

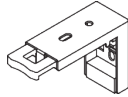

SG 8920

Bracket



SG 10731

Child safety retainer set

B. OPTIONAL PARTS



SG 8235

Side guide wire base short



SG 8236

Side guide wire base long



SG 8237

Side guide wire holder

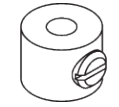

SG 8249

Side guide device



SG 10120

Side guide wire \varnothing 0.9 mm

