

# Hand Operated Curtain Track Systems





## Picture Hanging System

# Silent Gliss® 3600

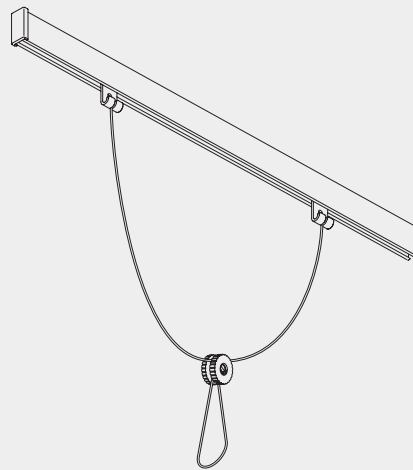

### Product Information

- Specially developed picture hanging system for the quick and precise hanging and moving of framed pictures
- Pictures can be moved vertically or horizontally without re-drilling the wall
- Suitable for domestic use as well as galleries, schools, banks, offices, etc.
- For pictures weighing up to 10kg
- Easy wall fixing with specially developed button-fix brackets
- Standard colours: silver, white, gold, bronze, black or cream
- Can be bent



3600

## Profile, Bending and Specification Information

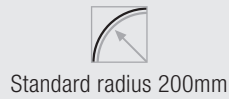
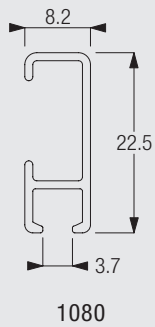

### Specification guide - download from [www.silentgliss.co.uk](http://www.silentgliss.co.uk) (password required)

Silent Gliss 3600 picture hanging system supplied made to measure and complete comprising anodised aluminium profile 1080 in satin silver or powder coated white as standard and hanging set 3665. Specially developed for the quick and precise hanging or moving of pictures. Profile optional in bronze, gold, black, cream, gunmetal and chrome effect. Maximum Weight per picture 10KG.

## Fitting Information

### Bracket 3606 fixing points



Fix invisible snap fastener brackets approx. every 30 - 50cm.



Click on and off snap fastener 3606.



### Hanging up of picture with Set 3600

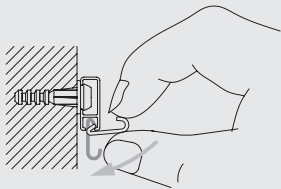

Click-in hooks 3663 as shown on the picture.

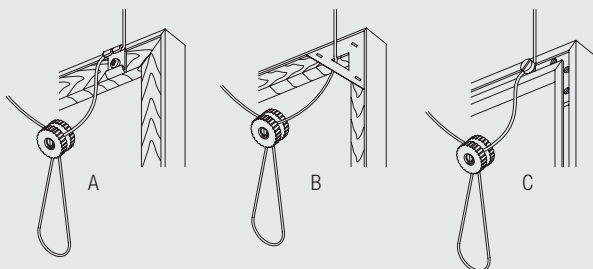

A: Fixing cords with hooks 3663  
 B and C: Fixing cords by using existing frame hangers  
 Adjust and fix cord by turning the plastic screw.

## Fitting Options

### Direct to wall fixing of snap fastener bracket 3606

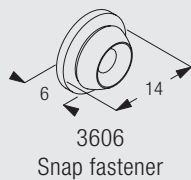
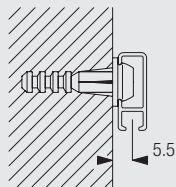

## Standard Accessories

### Standard set

3600	Picture hanging set, containing	3634	Height adjuster	1	
		3637	Cord (ø 1.5mm)	5m	
		3663	Hook	4	

## Components

1080	Profile		3604	Corner piece	
3605	End cover		3606	Snap fastener	
3634	Height adjuster		3637	Cord (ø 1.5mm)	
3657	Connecting bridge		3663	Hook	

## Useful Measurements

3657	Connecting bridge	
------	-------------------	--



3600



3600

[www.silentgliss.co.uk](http://www.silentgliss.co.uk)

[www.silentglissglobal.com](http://www.silentglissglobal.com)

Silent Gliss Ltd  
Pyramid Business Park  
Poorhole Lane  
Broadstairs  
Kent  
CT10 2PT  
Great Britain

Tel: +44 (0) 1843 863571  
Fax: +44 (0) 1843 864503  
[info@silentgliss.co.uk](mailto:info@silentgliss.co.uk)

Silent Gliss Global Ltd  
Pyramid Business Park  
Poorhole Lane  
Broadstairs  
Kent  
CT10 2PT  
Great Britain

Tel: +44 (0) 1843 874250  
Fax: +44 (0) 1843 874457  
[info@silentglissglobal.com](mailto:info@silentglissglobal.com)